



# MATERIAL SUPPLY STANDARD

Document No. ESF-500-STD-601

Version: 2.4

Published Date: 09 January 2026

### **Copyright information**

Copyright © Watercare Services Limited. All rights reserved.

### **Disclaimer**

Watercare Services Limited has endeavoured to ensure material in this document is technically accurate and reflects legal requirements. However, the document does not override governing legislation.

Watercare Services Limited does not accept liability for any consequences arising from the use of this document. If the user of this document is unsure whether the material is correct, they should refer directly to the relevant legislation and contact Watercare Services Limited.

### **More information**

If you have further queries, please contact the Asset Lifecycle team at [standards@water.co.nz](mailto:standards@water.co.nz)

## DOCUMENT CONTROL

### Document Owner

Role	Asset Lifecycle Manager
Organisation	Watercare Services Limited

## Version History

Version	Description of revision	By	Date
1	First release	J de Villiers	08/08/2016
1.1	Material updates	J de Villiers	20/12/2016
1.2	Knife gate section added. Minor updates to sections. New accepted materials added	J de Villiers	28/4/2017
1.3	New accepted materials. Minor corrections	J de Villiers	31/08/2017
1.4	New accepted materials. New sections added for control cabinets, VSD's and air circuit breakers. Major update to double flanged butterfly valve section and design schedule added for paint coating systems. Standardised water meters and supplier.	J de Villiers	01/06/2018
1.5	Updates to new added materials. Changes to flange facing requirements. Updates to electrical equipment	J de Villiers	25/01/2019
1.6	New products added. Minor specification update to switchboards. New specification for acoustic louvers	J de Villiers	26/06/2019
1.7	Updated products, added images and minor section updates	J de Villiers	29/11/2019
1.8	Updated section and new materials added	J de Villiers	25/03/2020
1.9	Updated sections and new materials added	J de Villiers	28/08/2020
1.10	Updated sections and new materials added	J de Villiers	15/12/2020
1.11	Updated sections and new materials added	J de Villiers	30/07/2021
2	Document format updated and new sections added including application for new materials. New materials added.	W Strydom	11/12/2023
2.1	Updated sections, new sections and new materials.	W Strydom	15/07/2024
2.2	Updated sections, added new sections and materials	W Strydom / Z Tizmaghz	12/03/2025
2.3	Updated sections, added new sections and materials	W Strydom	09/10/2025
2.4	Updated sections, added new sections and materials	C Solomon	09/01/2026

## Summary of Changes

Version	Section	Description of revision
	7	Items added to Product life expectancy
	13.1.5	New product added to section
	13.8.4	General requirements updated to section, removal of sacrificial liner for local network manholes
	13.2.11	Updated product photo
	13.2.11	New product added to section
	13.9.2	New product added to section
	13.11.7	Updated general requirements, updating model alternatives
	13.12	Communication protocols updated in general requirements
	13.12.1	Standardised products table name and contents updated- Control System to Digital Products
	13.12.3	New product added to section
	13.13	Electrical, standardised products table updated, sections removed and added to Digital standardised products table
	13.13.4	Switchboards, general requirements updated
	13.13.4	New product added to section
	13.13.5	New product added to section
	13.13.6	Electric Actuators, general requirements updated
	13.13.6	Procurement schedule, updated and accepted products updated
	13.13.12	Variable Speed Drives (VSD), general requirements updated

*The latest version of this standard takes effect on the date of release on all new work and supersedes all prior versions or formats of this document relating to the supply of materials for use with Watercare infrastructure.*

*Where design work has been completed or where construction work commenced, immediate adoption may be delayed unless the change is required within a timeframe provided by legislation, is an immediate health and safety concern or product failures have been known to occur.*

## Table of contents

<b>1</b>	<b>INTRODUCTION .....</b>	<b>10</b>
1.1	PURPOSE AND SCOPE .....	10
1.2	APPLICABILITY .....	10
1.3	'MUST' VERSUS 'SHALL' VERSUS 'WILL' .....	10
<b>2</b>	<b>QUALITY CONTROL AND QUALITY ASSURANCE.....</b>	<b>10</b>
2.1	GENERAL REQUIREMENTS .....	10
2.2	CHANGES AFFECTING QUALITY.....	11
<b>3</b>	<b>GENERAL DOCUMENT SUBMITTAL REQUIREMENTS FOR MATERIAL ACCEPTANCE .....</b>	<b>11</b>
3.1	APPLICATION AND APPROVAL PROCESS FOR NEW PRODUCTS .....	11
3.2	APPLICATION FORM.....	14
<b>4</b>	<b>REFERENCED STANDARDS .....</b>	<b>15</b>
<b>5</b>	<b>RECYCLED AND REUSED MATERIALS .....</b>	<b>16</b>
<b>6</b>	<b>HEALTH AND SAFETY .....</b>	<b>16</b>
<b>7</b>	<b>PRODUCT LIFE EXPECTANCY.....</b>	<b>16</b>
<b>8</b>	<b>PRODUCT MARKINGS, TRACEABILITY, AND PARTS.....</b>	<b>18</b>
8.1	GENERAL REQUIREMENTS .....	18
8.2	REPLACEMENT PARTS .....	18
<b>9</b>	<b>MATERIAL WARRANTY .....</b>	<b>18</b>
<b>10</b>	<b>MATERIAL HANDLING .....</b>	<b>19</b>
<b>11</b>	<b>GALVANIC AND CORROSION COMPATIBILITY OF DISSIMILAR METALS .....</b>	<b>19</b>
<b>12</b>	<b>MATERIAL APPLICATION GUIDELINE .....</b>	<b>21</b>
<b>13</b>	<b>MATERIAL MANUFACTURE, TESTING AND PERFORMANCE REQUIREMENTS .....</b>	<b>27</b>
13.1	PIPE AND PIPE FITTINGS.....	28
13.1.1	<i>Concrete pipe .....</i>	<i>28</i>
13.1.2	<i>Vitrified clay (VC) pipe and fittings for non-pressure applications.....</i>	<i>30</i>
13.1.3	<i>Polyvinylchloride, modified (PVC-M) pipe for pressure applications.....</i>	<i>31</i>
13.1.4	<i>Polyvinylchloride, oriented (PVC-O) pipe for pressure.....</i>	<i>32</i>
13.1.5	<i>Polyvinylchloride, un-plasticised (PVC-U) pipe for pressure and non-pressure applications</i> <i>33</i>	<i>33</i>
13.1.6	<i>Polyethylene (PE) pipe including fabricated bends and tees .....</i>	<i>37</i>
13.1.7	<i>Polyethylene (PE) fittings other than fabricated bends and tees .....</i>	<i>41</i>
13.1.8	<i>Glass reinforced plastic (GRP/FRP) pipe and fittings .....</i>	<i>47</i>
13.1.9	<i>Spiral welded steel pipe .....</i>	<i>48</i>
13.1.10	<i>Stainless steel pipe .....</i>	<i>54</i>
13.1.11	<i>Ductile iron castings for pipe, fittings and valves .....</i>	<i>56</i>
13.1.12	<i>Ductile iron pipe and pipe fittings .....</i>	<i>57</i>
13.1.13	<i>Seamless steel pipe and fittings.....</i>	<i>59</i>
13.2	VALVES .....	60
13.2.1	<i>Gate valves 50mm diameter and greater .....</i>	<i>60</i>
13.2.2	<i>Butterfly valves – Double flanged.....</i>	<i>66</i>
13.2.3	<i>Butterfly valves – Lugged or tapped flange.....</i>	<i>74</i>
13.2.4	<i>Gearboxes for valves .....</i>	<i>78</i>
13.2.5	<i>Valve extension spindles.....</i>	<i>80</i>

13.2.6	Control valves – Solenoid and piloted hydraulic actuated valves .....	82
13.2.7	Air release/vacuum valves for sewer applications .....	84
13.2.8	Air release/vacuum valves for water supply .....	85
13.2.9	Hydrant valves .....	87
13.2.10	Gate valves smaller than 50mm – Water use only .....	88
	Ball valves for water and wastewater .....	91
13.2.11	Non-return valves >50mm for pressure applications .....	92
13.2.12	Check valves <50mm for water and wastewater .....	94
13.2.13	Backflow preventers .....	95
13.2.14	Boundary kits for pressure wastewater collection (PWC) system .....	100
13.2.15	Knife gate valves 50mm diameter and greater .....	101
13.2.16	Globe valves (stopcock) 50mm diameter and smaller .....	103
13.2.17	Penstocks .....	105
13.3	COUPLINGS AND CONNECTIONS .....	106
13.3.1	Mechanical couplings, un-restrained, for water supply and sewer .....	106
13.3.2	Mechanical couplings, restrained, for water supply and sewer .....	108
13.3.3	Mechanical couplings, flexible restrained joints for articulation and expansion .....	111
13.3.4	Repair and off-take repair clamps for water supply .....	115
13.3.5	Couplings (banded) for sewer gravity applications .....	117
13.3.6	118	
13.3.7	Tapping bands for water connections .....	119
13.3.8	Roll-groove couplings and fittings for water supply and wastewater .....	121
13.4	FLANGES .....	123
13.5	BOLTS AND NUTS .....	125
13.6	WASHERS .....	126
13.7	GASKETS FOR FLANGES .....	126
13.8	MANHOLES AND STREET-WARE .....	128
13.8.1	Covers for manholes and chambers .....	128
13.8.2	Surface boxes for housing meters and valves .....	130
13.8.3	Manhole safety grilles .....	133
13.8.4	Prefabricated manholes in Concrete, PP, PE, or GRP .....	134
13.8.5	Ladders and step rungs for chambers .....	138
13.8.6	Manhole invert connectors .....	139
13.9	PUMPS .....	141
13.9.1	Grinder pumps for private sewer application .....	141
13.9.2	Submersible pumps for sewer pumping stations .....	145
13.9.3	Pumps for water supply and wastewater dry mounted .....	147
13.9.4	Dewatering pumps for chambers .....	148
13.10	CORROSION PROTECTION .....	149
13.10.1	Corrosion protection tapes – cold applied and prefabricated .....	149
13.10.2	Corrosion protection – fusion bonded polyethylene coatings .....	151
13.10.3	Painting systems for pipe and equipment protection .....	152
13.11	CATHODIC PROTECTION .....	161
13.11.1	Cathodic protection anodes .....	161
13.11.2	Cathodic protection Zinc reference .....	161
13.11.3	Cathodic protection – Electrical probes and corrosion coupons .....	161
13.11.4	Cathodic protection flange insulation kits .....	161
13.11.5	Cathodic protection monolithic insulation joints .....	162
13.11.6	Cathodic Protection test stations .....	162
13.11.7	Cathodic protection power supplies .....	162
13.11.8	Cathodic protection services .....	163
13.12	INSTRUMENTATION AND CONTROL .....	164

13.12.1	General requirements for all instrumentation .....	164
13.12.2	Turbidity meters.....	173
13.12.3	Meters for water supply – Volumetric and turbine type .....	174
13.12.4	Meters – electromagnetic flow type.....	175
13.13	ELECTRICAL.....	179
13.13.1	General requirements for all electrical components.....	179
13.13.2	Luminaires.....	188
13.13.3	Socket outlets.....	190
13.13.4	Switchboards.....	192
13.13.5	Control panel manufacture and supply .....	198
13.13.6	Electric actuators.....	202
13.13.7	Uninterruptable power supply (UPS).....	205
13.13.8	Motors.....	206
13.13.9	Cable and connectors .....	208
13.13.10	Cable support and conduit .....	213
13.13.11	Fibre optic cable, ducting and components.....	214
13.13.12	Variable speed drives (VSD) .....	218
13.13.13	Air circuit breakers (ACB).....	223
13.14	ACOUSTIC LOUVERS.....	224
13.15	HANDRAILS, BALUSTRADES AND ACCESS STRUCTURES.....	224
13.16	PRODUCTS FOR THE PROTECTION AND REPAIR OF CONCRETE STRUCTURES.....	225
<b>14</b>	<b>MISCELLANEOUS ACCEPTED PRODUCTS .....</b>	<b>228</b>
<b>15</b>	<b>STANDARD PRODUCT SOLUTIONS.....</b>	<b>231</b>
15.1	DOMESTIC METER SOLUTIONS.....	231

## Definitions

Accepted material	Materials that have been evaluated for general use, or for a specific function in an operational area. Acceptance does not imply exclusive
-------------------	--

use. Materials not on this list require evaluation against Watercare's materials standards prior to being used.

Assets	Water, wastewater, and supporting infrastructure owned and operated by Watercare, anything of financial value or provides service potential.
Infrastructure	Facilities or linear assets in an operational capacity that is managed by a controlling authority
Standardised material	Materials that shall be exclusively used for a specific operational area or function. In some instances, materials under this list are provided under commercial agreements that ensure long term serviceability, component compatibility, availability of spare parts, etc.
Local networks	Reticulated distribution piping that is downstream connected from a transmission water main bulk supply point or upstream from a wastewater bulk collection sewer where the peak dry weather flow is less than 78l/s.
Transmission	High volume supply (water) or collection (wastewater) for conveying liquid in bulk over long distances. Water is potable (after treatment stage in Water Supply – ref. “Water Supply”) and reticulated between reservoirs. Reservoirs are included.
Water supply	Raw water collection into dams or abstraction from rivers or wells, including conveyance to treatment facilities and the treatment process. These facilities are also referred to as “headworks”.
Treatment	Conditioning of the receiving and outgoing liquid. (see “Water supply”) Water treatment plants for the treatment of raw water by mechanical or chemical processes to meet the Drinking Water Standards for New Zealand, or Wastewater treatment that receives wastewater from Wastewater transmission (ref. “Transmission”) to remove contaminants through mechanical, chemical and biological processes.

# 1 Introduction

## 1.1 Purpose and Scope

This document is intended to be used by designers and suppliers to ensure that the intended whole of life asset performance outcomes are achieved. Each section specific to a material type includes a procurement template to assist firstly the designer to identify the design specific requirement over and above the minimum material specification and secondly for the supplier to demonstrate compliance or justify an alternative offer. Where the referenced standards are not met the designer must confirm the product is fit for purpose and complies with a recognised alternative standard or otherwise reject the proposal. Alternatives must be presented to Watercare through an **Application for Dispensation**, after which the product will be evaluated for acceptance at Watercare's discretion.

It must be noted that Watercare's acceptance of a product does not imply product certification. Certification of conformity must be completed by the products' supplier through a third-party certification body, as outlined. Neither does acceptance provide a guarantee of procurement and shall not infer or express acceptance of any conditions of quotation, sales, supply, stock, or delivery.

Also note that third-party certification does not automatically guarantee Watercare acceptance.

## 1.2 Applicability

This standard provides the minimum requirements for the supply of material (and products) that will be used in construction or vested to Watercare as "Assets".

## 1.3 'Must' versus 'Shall' versus 'Will'

Where the verbs must, shall and will (or past tense forms) are used, they describe a requirement for compliance with the statement in which it is used.

'Shall' and 'must' expresses a mandatory condition or action. 'Will' is used to prescribe a performance outcome or intent.

# 2 Quality control and Quality assurance

## 2.1 General requirements

Quality must be demonstrated by presenting valid and recent certification which will endure for the required individual product approval timeline, as specified in each of the material sections.

Manufacturing processes must demonstrate current accreditation with ISO 9001 for quality management systems by an industry recognised certifier.

Watercare typically requires 3<sup>rd</sup> party ISO type 5 certification by a suitable accreditor. Refer to ISO 17067, table 1 for the various product certification schemes.

Accepted and standardised products must demonstrate ongoing compliance. Product manufacture and testing certifications shall be made available with every procurement to demonstrate currency

of the certification. Accepted and standardised products listed are typically re-evaluated every three years unless:

- The product design or material element is varied from the assessed product
- The product fails to perform in service to the stated performance and is terminated from the listing
- When the Watercare requirements are altered, resulting in a potential non-compliance
- The product acceptance is withdrawn at Watercare's discretion

## 2.2 Changes affecting quality

Any proposed material or product change shall not compromise quality, safety, and regulatory requirements. Where a change is proposed, and Watercare acceptance is required, the burden of proof is on the applicant to correctly evaluate and demonstrate that:

- The material or product is fit for purpose and meets the design requirements
- The material or product meets the minimum specified performance in the installation environment, or is of equivalent or better standard
- The product or material is tested to comply and is manufactured under repeatable processes
- The product or material is safe for use - providing either no risk or an acceptable level of risk, considering the normal or reasonably foreseeable use of the product or material

## 3 General document submittal requirements for material acceptance

All material or material acceptance applications shall be a provided with the following minimum documentation:

- Manufacturing quality assurance
- Test certifications / certificates of conformity
- Supporting documents demonstrating compliance with minimum requirements set out in the Material Standard (this document)
- Installation documentation
- Operation and maintenance manuals that includes replacement parts lists and expected replacement frequency
- Transfer of warranties and guarantees to Watercare when commissioned or vested

### 3.1 Application and approval process for new products

New material or product applications are assessed to confirm that products are compliant with national and international manufacturing standards and aligns with Watercare's functional requirements to operate over the expected service life listed in [Section 7](#) below.

The steps below describe the application process:

**Step 1:** The applicant completes the application form including supporting documentation (refer to checklist) and clearly identifies what has been submitted and omitted from the application, if not applicable.

**Note:** All documentation shall be appropriately named so they are identifiable as per the compliance requirements, e.g., for polyethylene pipes:

- AS/NZS 4130 (ISO Type 5 Test).pdf
- AS/NZS 4020 certification.pdf
- ISO 9001 Quality Management Certification.pdf
- ISO 14001 Environmental Management Certification.pdf

**Unrecognizable or misrepresentative file names shall not be considered for assessment**

**Step 2:** Completed application documentation must be submitted by email to: [standards@water.co.nz](mailto:standards@water.co.nz). Printed (paper) copies will not be accepted.

**Step 3:** Watercare performs initial screening to confirm completeness of submission and compliance with all applicable industry (national and international) standards specific to the material / products quality assurance. Examples include compliance with manufacturing standards and product certification.

**Step 4:** Once compliance with industry standards is demonstrated, the material or product submission is reviewed by Watercare's Technical Working Group. This assessment reviews asset attributes such as:

- Demonstrated or referenced reliability of the proposed material or product
- Health and Safety considerations when installing and operating the material or product
- Financial viability (value for money throughout the asset's lifecycle)
- Maintenance and renewal requirements including support and availability of spares
- Legislative compliance

**Step 5:** Following the review process an agreed recommendation will be put forward by the Technical Working Group based on the completeness and compliance of the application, and alignment with Watercare's Infrastructure Asset Strategy.

**Step 6:** The applicant is notified by email with a letter regarding the outcome of the application.

**Step 7:** If the material or product is approved, it will be listed in the next revision of the 'Material Standards' publication.

**Legend**

 Action required by applicant

 Action required by Watercare

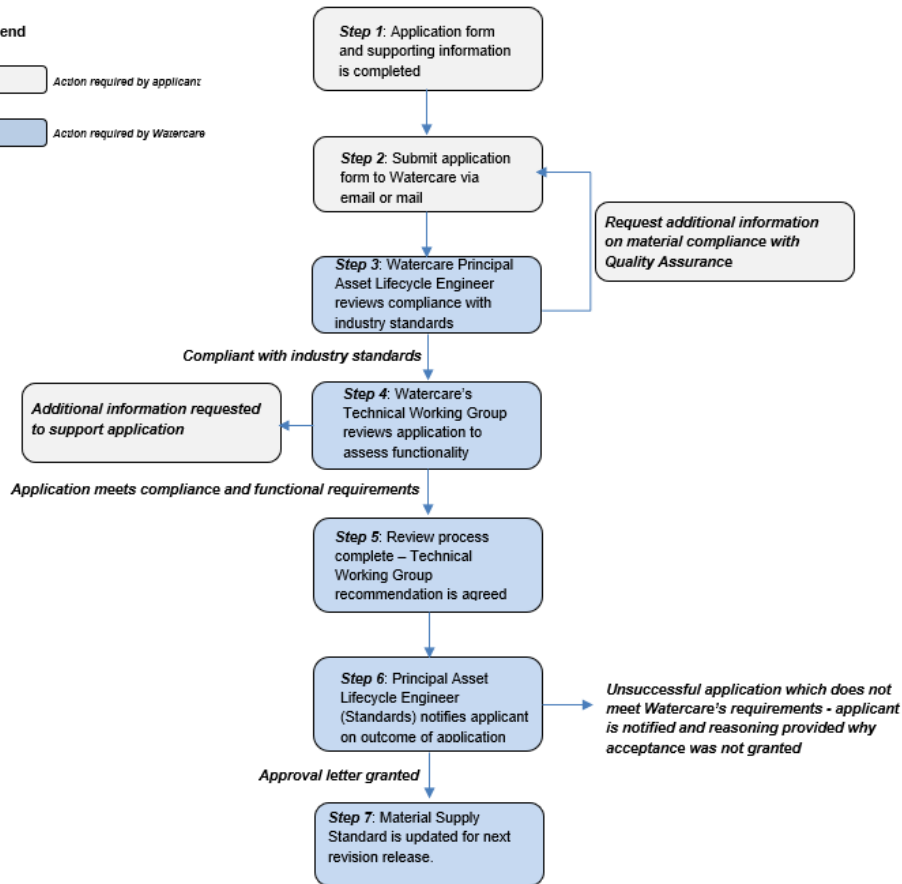

## 3.2 Application Form

<b>Applicant Name:</b>		<b>Phone No.</b>	
<b>Product and Model:</b>			
<b>Applicant Address:</b>		<b>Mobile No:</b>	
		<b>Email:</b>	
		<b>Date:</b>	
<b>Contact Person:</b>		Application No. (Provided by Watercare)	

Please submit the requested information on each of the items listed below. If this is not applicable to the material / product, please tick the 'Not Applicable' box.

Requirements	Included	Not Applicable
1. Material / Product background – intended purpose of material / product	<input type="checkbox"/>	<input type="checkbox"/>
2. Material / Product history including track record if used by other local authorities	<input type="checkbox"/>	<input type="checkbox"/>
3. Manufacturers details	<input type="checkbox"/>	<input type="checkbox"/>
4. Specification	<input type="checkbox"/>	<input type="checkbox"/>
5. Drawing or photo of product	<input type="checkbox"/>	<input type="checkbox"/>
6. Compliance with national or international standards (including test results)	<input type="checkbox"/>	<input type="checkbox"/>
7. Installation and operational instructions	<input type="checkbox"/>	<input type="checkbox"/>
8. Maintenance requirements	<input type="checkbox"/>	<input type="checkbox"/>
9. Life expectancy of product	<input type="checkbox"/>	<input type="checkbox"/>
10. Sample provided	<input type="checkbox"/>	<input type="checkbox"/>
11. Quality assurance <ul style="list-style-type: none"> <li>a) Manufacturing standard compliance</li> <li>b) Product certification by an accredited body</li> <li>c) Drinking water safe (if applicable)</li> <li>d) Meets minimum functional requirements (e.g., Pressure rating, coating, material grade, etc.)</li> </ul>	<input type="checkbox"/>	<input type="checkbox"/>

12. Reference from current users (e.g., other water authorities). Please include: a) Organisation referee reports to b) Referee's position within the organisation c) Referee's contact details (Phone No. and email address) d) Experience with material / product applied for e) Project(s) where this material / product has been used and documented performance	<input type="checkbox"/>	<input type="checkbox"/>
13. Price of product	<input type="checkbox"/>	<input type="checkbox"/>
14. Compatibility with other items/equipment used	<input type="checkbox"/>	<input type="checkbox"/>
15. Environmental product declaration (EPD) – if available	<input type="checkbox"/>	<input type="checkbox"/>

Please return the completed application form with all supporting documentation attached to: **Email:** [standards@water.co.nz](mailto:standards@water.co.nz)

## 4 Referenced Standards

This standard refers to a number of national and international standards under each material section. It is the obligation of manufacturers and material suppliers to ensure they make use of the cited standard, or if not cited, the latest version of the applicable standard until such time that this document can be amended.

### Informative:

- ISO 9001 Quality Assurance Certification
- AS/NZS ISO/IEC 17067 Conformity assessment – Fundamentals of product certification and guidelines for product certification schemes
- ISO/IEC TR 17026 Conformity Assessments – Examples of certification scheme for tangible products
- AS 4738.1 Metal Castings – Part 1: Ferrous Sand Moulded
- AS 3507.1 Part 1: Non-Destructive Testing – Part – Guide to Radiography for ferrous castings
- AS 3507.2 Part 2: Non-Destructive Testing – Radiography Determination of quality of ferrous castings
- AS 4314 Founding – Pattern, pattern equipment and core boxes for the production of sand moulds and sand cores
- AS 3978 Non-Destructive Testing – Visual inspection of metal products and components
- AS 1816 Metallic Materials – Brinell hardness Tests
- AS 1816.1 Part 1: Test Method (Adapted ISO 6506.1-1997 MOD)
- ASTM A941 Standard terminology relating to steel, stainless steel, related alloys and ferroalloys
- ASTM A644 Terminology used in common reference to iron castings
- ASTM A834 Common requirements for Iron Casting for general industrial use

## 5 Recycled and reused materials

Recycled material and material reuse shall not be accepted unless specifically required by instruction from Watercare.

## 6 Health and Safety

Any product or component intended for use in contact with the water supply system must demonstrate compliance with the requirements of AS/NZS 4020, Testing of Product for use in Contact with Drinking Water.

Where materials are of similar design which does not comply with the AS/NZS4020 standard and is not intended for use with drinking water its purpose must be clearly marked to exclude its use with drinking water.

All products and their components shall be free of asbestos fibres. Products must be specified and used for their intended purpose only.

Electrical equipment and machine assemblies must comply with the requirements of the Health and Safety at Work Act 2015. The relevant AS/NZS-4024 standard shall be used in the design and risk assessment of machine assemblies. Technical documentation shall be provided that includes diagrams, calculations, test reports and any other documentation relevant to conformity with the relevant AS/NZS 4024 standard.

Safety functions must be verified, after both the design and commissioning stages.

Any hazards that cannot be eliminated but are instead reduced, must be defined and appropriate information provided to prevent harm.

## 7 Product life expectancy

The table below lists the expected service life products shall meet. A supplier's manufacturing, quality control, testing, and compliance practices are required to clearly demonstrate product support, operation and reliability over this period.

Product type	Effective operational life
Pipe and pipe fittings	100 years
Valves	50 years
Couplings and connections	50 years
Flanges	100 years
Bolts, nuts and washers	100 years

<b>Product type</b>	<b>Effective operational life</b>
Gaskets	100 years
Manholes and storage tanks	100 years
Valve and meter boxes	50 years
Lids on manholes and valve boxes	50 years
Pumps ≤ 15kW	15 years
Pumps > 15kW	25 years
Motors	15 years
Instrumentation	15 years
Electrical componentry	25 years
Cabinetry for instrumentation and electrical equipment	50 years
RTUs (Remote Terminal Units) & PLCs (Programmable Logic Controllers)	15 years
Industrial gateways and protocol converters	15 years
Computer Servers and Desktops	5 years
Network switches (industrial-rated)	10 years
Field radios (industrial-rated)	10 years
Cellular modems / routers	5 years
UPS systems and DC power supplies	15 years
Human–Machine Interfaces (HMI panels - Non-PC Type)	15 years
Human–Machine Interfaces (HMI panels – Industrial PC Type)	10 years
Ethernet cabling and fibre optic links	25 years
Antennas and RF cabling	15 years

Product type	Effective operational life
Security appliances (firewalls, VPN gateways)	10 years
Cybersecurity monitoring appliances (Nozomi, etc.)	10 years
Network switches (industrial-rated)	10 years
Field radios (industrial-rated)	10 years
Corrosion protection	50 years
Handrails and balustrades, and Access Structures	30 years
Pipeline rehabilitation products	50 years

## 8 Product markings, traceability, and parts

### 8.1 General requirements

All products shall be marked in accordance with the conformity assessment body's requirements. This may include a standards marking on the product or an alternative means of identifying the product's conformance against the testing standard.

Materials and componentry shall be traceable via a numbering system to the individual product, or batch, as applicable that will allow manufacturing records to be verified against the standards. The manufacturing records shall include the manufacturing process records, process tolerances, material properties and testing results.

### 8.2 Replacement parts

Replacement parts shall be readily available and in accordance with the approved renewals and maintenance plan. A minimum of two sets of tools required for routine maintenance or repair shall be provided to Watercare's identified maintenance crews.

## 9 Material warranty

Watercare may require materials to carry a warranty from the date of installation for between 12 and 60 months. The warranty period will be established based on the expected level of service of the material and the associated risk of premature failure to Watercare and its customers.

Typically, local network distribution materials (excluding pump stations, control systems and associated equipment), would generally not require a warranty to be extended beyond that offered by the supplier as standard.

The warranty shall guarantee performance, manufacturer workmanship and components, including but not limited to assembly, welding or post assembly treatment compatibility.

During the warranty period the supplier shall be responsible for rectification of all defects and faults in the equipment supplied due to faulty materials and/or workmanship and for all costs of consequential work to repair damage due to such faults.

Material or products purchased and installed / commissioned by contractors, developers or their agents shall transfer with ownership, all product guarantees and warranties to Watercare. Materials or products shall not be accepted otherwise.

## 10 Material handling

Materials or products shall be provided with the manufacturer's handling and storage instructions. Any damage caused through the absence of these instructions shall be carried by the supplier.

Materials shall be handled and stored in accordance with the manufacturer's recommendation. Any damage or product failure as a result of poor handling by contractors, developers or their agents shall be replaced or repaired to the satisfaction of Watercare by the party responsible for handling the material.

## 11 Galvanic and corrosion compatibility of dissimilar metals

**Harsh environments:** The Anodic index difference between materials must be  $\leq 0.15V$ . Harsh environments include but are not limited to outdoors, buried, high humidity or high salt.

**Normal environments:** The Anodic index difference between materials must be  $\leq 0.25V$ . Normal environments include but are not limited to above ground buildings and where humidity is controlled, but not temperature.

**Controlled environments:** The Anodic index difference between materials must be  $\leq 0.5V$ . Controlled environments include but are not limited to enclosed structures i.e. where temperature and humidity is controlled. Controls must be strict, and risk based.

Metallurgic category	Anodic index (V)
Gold, solid and plated, Gold-platinum alloy	0.00
Rhodium plated on silver-plated copper	0.05
Silver, Solid or plated, Monel metal. High nickel-copper alloys	0.15
Nickel, solid or plated, titanium alloys, Monel	0.30
Copper, solid or plated; low brasses or bronzes, silver solder, German silvery high copper-nickel alloys, nickel-chromium alloys	0.35

<b>Metallurgic category</b>	<b>Anodic index (V)</b>
Brass and bronzes	0.40
High bronzes and bronzes	0.45
18% chromium type corrosion-resistant steels	0.50
Chromium plated, tin plated; 12% chromium type corrosion-resistant steels	0.60
Tin-plate; tin-lead solder	0.65
Lead, solid or plated; high lead alloys	0.70
Aluminium, wrought alloys of the 2000 series	0.75
Iron, wrought, grey or malleable, plain carbon and low alloy steels	0.85
Aluminium, wrought alloys other than 2000 series aluminium, cast alloys of the silicon type	0.90
Aluminium, cast alloys other than silicon type, cadmium, plated and chromate	0.95
Hot-dip zinc plate, galvanised steel	1.20
Zinc, wrought, zinc-base die-casting alloys; zinc plated	1.25
Magnesium and magnesium-base alloys, cast or wrought	1.75
Beryllium	1.8

## 12 Material application guideline

Pipe materials	Normative standard	Pressure Wastewater	Gravity Wastewater	Water supply	Plants and processes	Selection notes
PVC-U	AS/NZS 1260	✘	✓ (Networks only)	✘	✓	Gravity applications only. Suitable for aggressive groundwater, anaerobic and tidal zones. Can be used for trenchless installations with suitable load resistant joints
PVC-U	AS/NZS 1477	✓ (Networks only)	✘	✓ (Networks only)	✓	Alternative installation techniques possible e.g. slip lining. Suitable for aggressive groundwater, anaerobic conditions, and tidal zones. Can be used for trenchless installation with suitable end load resisting joints. Specific design for dynamic stresses (fatigue) required for pressure applications.
PVC-M	AS/NZS 4765	✓ (Networks only)	✘	✓ (Networks only)	✓	Improved fracture toughness and increased hydraulic capacity compared to PVC-U. Inferior fatigue resistance compared to PVC-U and PVC-O. Suitable for aggressive groundwater, anaerobic and tidal zones. Specific design for dynamic stresses (fatigue) required for pressure applications.
PVC-O	AS/NZS 4441	✓	✘	✓	✓	Improved fracture toughness compared to PVC-U. Improved fatigue resistance compared to PVC-U and PVC-M. <b>NOTE – Use only DI fittings in pumped mains to achieve full fatigue resistance.</b> Has increased hydraulic capacity compared with PVC-U and PVC-M. Suitable for aggressive groundwater, anaerobic conditions, and tidal zones. Specific design for dynamic stresses (fatigue) required for pressure applications.

Pipe materials	Normative standard	Pressure Wastewater	Gravity Wastewater	Water supply	Plants and processes	Selection notes
PE	AS/NZS 4130  AS/NZS 4131  AS/NZS 4129	✓	✗	✓	✓	<p>Generally, for pressure applications but limitation placed on size and application in Transmission areas. Retrospective installation of fittings / repair is complicated.</p> <p>Can be curved to eliminate the need for bends.</p> <p>Alternative installation techniques, e.g. pipe cracking, directional drilling and slip lining.</p> <p>Can be welded to form an end load resistant system.</p> <p>Compression couplings and end load resistant fittings are available in smaller diameters.</p> <p>Pipe longitudinal flexibility accommodates large differential ground settlement.</p> <p>Fusion jointing requires qualified skilled installers and special equipment.</p> <p>Specific design for dynamic stresses (fatigue) required for pressure pumping applications.</p> <p>≤ DN 125 are available in long coiled lengths for fewer joints.</p> <p>Suitable for aggressive groundwater, anaerobic and tidal zones <b>but not where some hydrocarbons are present</b>. Suitable for ground with high subsidence potential.</p> <p>PE pressure fittings, including mechanical, compression, or electrofusion as approved by Watercare. Welding requires skilled and suitably qualified installers.</p> <ul style="list-style-type: none"> <li>• Butt fusion is preferred over electrofusion. Electrofusion should only be used where end connections or tie-ins are made.</li> <li>• Electrofusion fittings are preferred over mechanical couplings. Limitations are placed on the size of mechanical fittings that can be used.</li> </ul>
PE	AS/NZS 5065	✗	✓	✗	✗	<p>Only for gravity applications. Alternative installation techniques possible e.g. pipe cracking and slip lining. Can be welded to form an end load resistant system.</p>

Pipe materials	Normative standard	Pressure Wastewater	Gravity Wastewater	Water supply	Plants and processes	Selection notes
						<p>Fusion jointing requires skilled installers and special equipment.</p> <p>Retrospective installation of fittings / repair complicated.</p> <p>Smaller diameters available in long coiled lengths for fewer joints.</p> <p>Suitable for aggressive groundwater, anaerobic and tidal zones.</p> <p>Not suitable for ground with high subsidence or weak support.</p>
<b>GRP (Trenched)</b>	ISO 23856	✓	✓	✓	✗	<p>Alternative installation techniques possible using GRP, e.g., slip lining.</p> <p>UV resistant (special product).</p> <p>Custom made fittings can be manufactured.</p> <p>Suitable for use without additional corrosion protection in areas where stray electrical currents occur.</p> <p>Low impact resistance and ease of damage to thermosetting resin makes GRP susceptible to damage.</p> <p>Suitable for aggressive groundwater, anaerobic and tidal zones.</p>
<b>GRP (Jacking Pipes)</b>	ISO 25780	✓	✓	✓	✗	<p>UV resistant (special product). Custom made fittings can be manufactured. Suitable for use without additional corrosion protection in areas where stray electrical currents occur.</p> <p>Low impact resistance and ease of damage to thermosetting resin makes GRP susceptible to damage.</p> <p>Suitable for aggressive groundwater, anaerobic and tidal zones.</p>

Pipe materials	Normative standard	Pressure Wastewater	Gravity Wastewater	Water supply	Plants and processes	Selection notes
<b>VC</b>	BS EN 295-1	✘	✓ (Networks only)	✘	✘	<p>Gravity applications only for particularly aggressive industrial wastes. Not for general use.</p> <p>Not recommended for active seismic (earthquake) zones or unstable ground. Limited diameter application.</p>
<b>RRJRC</b> <b>(Rubber ring jointed reinforced concrete)</b>	AS/NZS 4058	✘	✓	✘	✘	<p>Requires protection from hydrogen sulphide attack in sewer applications by sacrificial layer, plastic lining, or appropriate cement additives.</p>
<b>CLS</b>	AS 1579	✓	✓	✓	✓	<p>Cement mortar lined, external coated according to installation environment.</p> <p>High mechanical strength and toughness. Easily customised, specially configured steel fittings can be made to order.</p> <p>Can be welded to form a system that will resist end load and joint permeation.</p> <p>Cathodic protection (CP) is required to electrically continuous pipelines to provide enhanced corrosion protection.</p> <p>Standard Portland cement is not resistant to H<sub>2</sub>S attack at any high points or discharge points in the main. High alumina cement has improved resistance.</p> <p>Welded joints require skilled installers and special equipment. Welded joints require reinstatement of protection system on site.</p> <p>Special design required for welded installations parallel and adjacent to high voltage transmission lines.</p> <p>Cathodic protection requires regular monitoring and maintenance.</p>

Pipe materials	Normative standard	Pressure Wastewater	Gravity Wastewater	Water supply	Plants and processes	Selection notes
						<p>Suitable for high load applications, such as railway crossings and major roads. Suitable for aerial or suspended pipeline applications.</p> <p>Gravity application considered for structural crossings.</p>
<b>ELS</b>	AS 1579	✓	✓	✓	✓	<p>Epoxy lined steel pipe, external coated according to installation environment. Limited use where pipeline can be removed such as process or plant environments.</p> <p>High mechanical strength and toughness. Easily customised, specially configured steel fittings can be made to order.</p> <p>Can be welded to form a system that will resist end load and joint permeation.</p> <p>Cathodic protection (CP) is required to electrically continuous pipelines to provide enhanced corrosion protection.</p> <p>Epoxy lining must be selected to suit specific environment – Note limited lifetime of linings and limitations of re-coating.</p> <p>Welded joints require skilled installers and special equipment. Welded joints require reinstatement of protection system on site.</p> <p>Special design required for welded installations parallel and adjacent to high voltage transmission lines.</p> <p>Cathodic protection requires regular monitoring and maintenance.</p> <p>Suitable for high load applications, such as railway crossings and major roads. Suitable for aerial or suspended pipeline applications.</p>
<b>DI</b>	AS/NZS 1831	✓	✓	✓	✓	<p>Fatigue analysis not normally required. High mechanical strength and toughness. Ease of jointing.</p>

Pipe materials	Normative standard	Pressure Wastewater	Gravity Wastewater	Water supply	Plants and processes	Selection notes
	AS 3681					<p>UV resistant / vandal proof / impact resistant. Well established methods of repair.</p> <p>Suitable for high pressure and above ground pipelines. Restrained joint systems available.</p> <p>Sufficient ring stiffness not to rely on side support for structural adequacy for the usual water supply installation depths. Elevated pH may occur when conveying soft water or in low flow extremities of reticulation mains.</p> <p>PE sleeving is required and must be repaired when damaged. Not suitable for aggressive ground water, anaerobic conditions, or tidal zones.</p> <p>Gravity application – normally considered for structural crossings only.</p>
<b>Stainless steel</b>	AS5200.053	✓	✓	✓	✓	<p>Performs well in high corrosion prone areas. Impact resistant and does not require additional lining or coatings in most situations.</p> <p>Welded joints require skilled installers and special equipment.</p> <p>Special design required for welded installations parallel and adjacent to high voltage transmission lines.</p> <p>Gravity application – normally considered for structural crossings only.</p>

## 13 Material manufacture, testing and performance requirements

The general requirements, quality assurance and quality control listed for products are the minimum criteria. The material sections include a register of accepted and standardised products that have been evaluated against the minimum standards.

**Note:** *The designer may require a product of higher performance or specific requirements that are fit for purpose, over the pre-assessed accepted products listed. The accepted products may not always be suitable as a default option.*

Where a procurement schedule is provided for a material type, it is to be completed by the designer for the specific performance requirements identified at design, where the requirements are different to the common standard. The designer shall not leave any spaces incomplete. Where the design does not require an additional or higher condition it shall be stated – i.e. “As per standard”. The supplier must confirm the product offered meets the minimum standard and state where the product does not comply or may comply with an alternative standard for consideration by the designer and Watercare.

All test certificates must be supplied for all products and component materials. Where test certificates to the applicable standard will be supplied at time of casting or manufacture, it must be stated, and an example provided for evaluation purposes e.g. ductile iron castings.

All electrical equipment must be supplied with the appropriate documentation and/or certification (e.g. Supplier Declaration of Conformity, Certificate of Compliance, Electrical Safety Certificate, Regulatory Compliance Mark, etc.). The documentation/certification shall confirm that the equipment is compliant with the New Zealand standards and is safe to connect to the electricity supply. If the documentation is not supplied, the costs associated with any testing, inspections, etc. needed to confirm compliance of the equipment shall be borne by the supplier.

## 13.1 Pipe and pipe fittings

### 13.1.1 Concrete pipe

#### General requirements

- a) Concrete pipe shall be reinforced, and manufactured to comply with AS/NZS 4058, and:
  - Accepted manufacturing processes shall be spun pipe with additional sacrificial layer of 25mm, or special concrete mixes (such as CaC) to prevent corrosion for the specific application.
  - Vibrated pipe that must be PE or PVC lined (on specific approval of a particular application) or a special concrete mix (such as CaC) used to prevent corrosion for the specific application.
  - Where a separate reinforcing cage is used for the socket, the cage shall overlap the barrel reinforcement by 50 diameters of the bar or wire
- b) Joint seals shall be natural rubber or EPDM complying with AS 1646 with a shore hardness of 40A to 60A.
- c) The minimum pipe class shall be load class 4.

#### Quality Control

The following minimum information shall be supplied with concrete pipes:



- a) Product shall be marked in accordance with the conformity assessment body's requirements.
- b) Type test – (ISO Type 5) to AS/NZS 4058, Table 5.1.
- c) Defects acceptability shall be to AS/NZS 4058, Section 3.4.2 and Table 3.6.
- d) Routine testing shall be provided as per the below table:

Routine testing:	Test	Frequency
	Concrete test and records	As per NZS 3104 – Batch records available on request As per NZS 3112.1 – Batch test records available on request
	Water tightness test (90 kPa)	AS/NZS 4058, Section 4.4, and a minimum of 1 pipe shall be sampled from pipe supplied
	Proof load test	AS/NZS 4058, Section A4.1, and minimum 2 pipes shall be sampled from pipe supplied
	Ultimate load	AS/NZS 4058, Section A4.2, and a minimum of 1 pipe shall be sampled from pipe supplied
	Water (Net) absorption <5.5%	As per AS/NZS 4058, Section A4.4
	Joint assembly test	AS/NZS 4058, Section A4.5, and a minimum of 1 joint test per batch supplied
	Reinforcement cover test	AS/NZS 4058, Section A4.6, and a minimum of 1 test per batch supplied
	Dimensional accuracy	As per AS/NZS 4058, Section A4.7
	Workmanship and finish	As per AS/NZS 4058 – Every pipe.

### Procurement schedule

Minimum standard required	Design specific requirements	Supplier submission
Application use description		
Nominal diameter (including additional lining)		
<b>Manufacturing standards:</b> AS/NZS 4058 as implemented by <a href="#">section 13.1.1</a>		
<b>Pipe class</b> Reinforced class per design specification (min class 3). Additional 25mm sacrificial internal concrete cover, or CaC concrete or PVC/PE lined on approval		
<b>Joints</b> 1. Flexible rubber ring spigot and socket 2. In-wall spigot and socket joint for jacking pipe		
<b>Joint seals</b> Natural rubber or EPDM to AS1646, Shore hardness of 40A to 60A		
Product and Test certificates		

### Accepted products

Product model/name	Image	Manufacturer/supplier	Specific limitation
Pinnacle pipe		Hynds	Fit for purpose
Perfect pipe		Hynds	Fit for purpose
Titan		Humes	Fit for purpose

### 13.1.2 Vitrified clay (VC) pipe and fittings for non-pressure applications

VC pipe and fittings are limited to network sewer gravity applications of up to 300mm diameter and installation in low seismic or low ground settlement risk areas only. These pipes are also used to form half-channels in manholes.

#### General requirements

- Pipe, fittings and jointing assemblies shall comply with EN 295-1.
- Special fittings, adaptors and compatibility accessories shall comply with EN 295-4.
- Elastomeric joint seals shall comply with AS1646 and AS 681.1 (or EN 681-1).
- Minimum crushing strength for DN 150 shall be 34 kN/m (class number not applicable). For larger nominal diameter the crushing strength shall comply with EN 295-1 in accordance with the specified designed class number.
- 90° saddles are not acceptable.

#### Quality Control

- All products shall be marked in accordance with the conformity assessment body's requirements.
- Pipe, fittings and jointing assemblies shall have product certification (ISO type 5) to EN 295-1 (Sampling in accordance with EN 295-2).
- Elastomeric joint seals shall have product certification (ISO type 5) to AS1646 and AS 681.1 (or EN 681-1).
- Special fittings, adaptors and compatibility accessories shall have product certification (ISO type 5) to EN 295-4.

#### Procurement schedule

Minimum standard required	Design specific requirements	Supplier submission
Application use description		
Pipe or fitting		
Nominal diameter		
<b>Manufacturing standard:</b> EN 295-1		
Minimum crushing strength for DN 150 shall be 34 kN/m		
<b>Joint seals</b> AS 681.1 performance specified		
Product and Test certificates		

#### 13.1.2.1 Accepted products

Product model/name	Image	Manufacturer/supplier	Specific limitation
Naylor		Humes	Wastewater networks

### 13.1.3 Polyvinylchloride, modified (PVC-M) pipe for pressure applications

Applies to pressure applications for water and wastewater in local network areas.

#### **General** requirements

- a) The minimum pressure rating shall be PN12.
- b) PVC-M pipes shall comply with AS/NZS 4765, Series 2 (for imperial compatibility when connecting to DI or existing AC), or Series 1 (metric).
- c) Elastomeric joint seals shall be EPDM complying with AS1646 and AS 681.1 (EN 681-1).
- d) Pipes for sewerage shall be legibly and durably marked with black lettering of at least 10mm high "SEWAGE – DO NOT DRINK" or equivalent repeated at intervals such that any length of unmarked pipe does not exceed 1m.

#### **Quality Control**

- a) All products shall be marked in accordance with the conformity assessment body's requirements.
- b) Pipes shall have product certification (ISO Type 5) to AS/NZS 4765.
- c) Elastomeric joint seals shall have product certification (ISO Type 5) to AS1646 and AS681.1.
- d) Certification of compliance with AS/NZS 4020 for water applications.

#### **Procurement schedule**

Minimum standard required	Design specific requirements	Supplier submission
Application use description		
Nominal diameter		
Internal diameter		
Networks minimum PN12		
Pipe series – specify series 1 or 2		
<b>Manufacturing standards:</b>		
AS/NZS 4765		
Pipe branding		
Pipe length		
Product and Test certificates		

#### **Accepted products**

Product model/name	Image	Manufacturer/supplier	Specific limitation
PVC-M		Marley/RXP-aliaxis	Local Networks

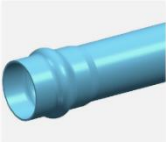
Product model/name	Image	Manufacturer/supplier	Specific limitation
RHINO (PVC-M)		Iplex Pipelines	Local Networks

### 13.1.4 Polyvinylchloride, oriented (PVC-O) pipe for pressure

Applies to pressure applications for water and wastewater in local network areas.

#### General requirements

- The minimum pressure rating shall be PN12.5.
- PVC-O pipes shall comply with AS/NZS 4441, Series 2 (for imperial compatibility when connecting to DI or existing AC), or Series 1 (metric).
- Elastomeric joint seals shall be EPDM or SBR complying with AS 1646 and AS 681.18 (EN681-1).
- Pipes for sewerage shall be legibly and durably marked with black lettering of at least 10mm high "SEWAGE – DO NOT DRINK" or equivalent repeated at intervals such that any length of unmarked pipe does not exceed 1m.



#### Quality Control

- All products shall be marked in accordance with the conformity assessment body's requirements.
- Pipes shall have product certification (ISO Type 5) to AS/NZS 4441.
- Elastomeric joint seals shall have product certification (ISO Type 5) to AS 1646 and AS 681.1.
- Certification of compliance with AS/NZS 4020 for water applications.

#### Procurement schedule

Minimum standard required	Design specific requirements	Supplier submission
Application use description		
Nominal diameter		
Internal diameter		
Networks minimum PN12.5		
Pipe series – specify series 1 or 2		
<b>Manufacturing standards:</b>		
AS/NZS 4441		
Pipe branding		
Pipe length		
Product and Test certificates		

#### Accepted products

Product model/name	Image	Manufacturer/supplier	Specific limitation
Apollo		Iplex Pipelines	Local Networks
PVC-O		Pipemakers Australia / Promains	Local Networks

### 13.1.5 Polyvinylchloride, un-plasticised (PVC-U) pipe for pressure and non-pressure applications

Applies to pressure and non-pressure applications for water and wastewater in local network areas.

#### General requirements

- a) Applicable standards for manufacture are:
  - PVC-U pipes for pressure applications shall comply with AS/NZS 1477 Series 2 (for imperial compatibility when connecting to DI or existing AC), or Series 1 (metric), with minimum pressure rating of PN12
  - PVC-U pipes for non-pressure applications shall comply with AS/NZS 1260 with minimum stiffness class SN16 unless otherwise specified.  
*Note: SN16 is typically used in developments and in the road corridor where temporary works and future road maintenance can cause pipe to deform.*
- b) Pipe joints:
  - **Solvent cement joints are not accepted for network applications.**
  - Elastomeric joints shall be EPDM, or CR, or SBR complying with AS 1646 and AS 681.1 (EN 681-1)
  - Threaded spigot and socket joints with elastomeric sealing ring shall be to the manufacturer's specification.
- c) Pipes for sewerage shall be legibly and durably marked with black lettering of at least 10mm high "SEWAGE – DO NOT DRINK" or equivalent repeated at intervals such that any length of unmarked pipe does not exceed 1m.



#### Quality Control

- a) All products shall be marked in accordance with the conformity assessment body's requirements.
- b) As specified by the applicable Watercare material supply standard specification.
- c) Pressure pipes shall have product certification (ISO Type 5) to AS/NZS 1477.
- d) Non-pressure pipes shall have product certification (ISO Type 5) to AS/NZS 1260.
- e) Elastomeric joint seals shall have product certification (ISO Type 5) to AS 1646 and AS 681.1.
- f) Certification of compliance with AS/NZS 4020 for potable water applications.



#### Procurement schedule

Minimum standard required	Design specific requirements	Supplier submission
Application use description		
Nominal diameter		
Internal diameter		
Networks pressure minimum PN12 Networks gravity minimum SN16		
Pipe series – specify series 1 or 2		
<b>Manufacturing standards:</b> Pressure: AS/NZS 1477 Gravity: AS/NZS 1260		
Pipe branding		
Pipe length		
Product and Test certificates		





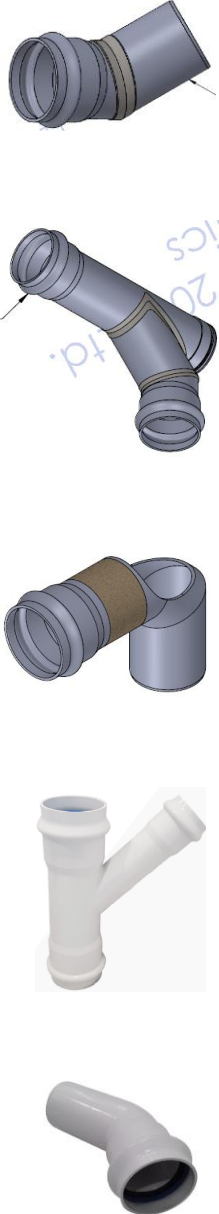

**Accepted products**

Product model/name	Image	Manufacturer/supplier	Specific limitation
		Marley	Within limitation of this standard. No solvent cement joints
Blue Brute, Novafuse, Novakey Novadrain & Restrain	 	Iplex Pipelines	Within limitation of this standard. No solvent cement joints for network pipes
SN16 Lundon junctions,  SN16 Wye junction, Wye with 45deg	  	Solo Plastics	Fittings. No solvent cement joints for network pipes. Note limitations of using Lundon junctions with certain pipe grades.

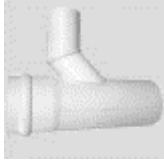

Product model/name	Image	Manufacturer/supplier	Specific limitation
<p>SN16 drop junctions  (Auckland, Waitakere, Manukau),  PVC manhole short,  SN16 bends,</p>			<p>Gritted manhole starters must be installed with hydrophilic seals and reinforced concrete collar cast insitu</p>
<p>Powe—Lock  Sewer-Lock</p>		<p>RXP-aliaxis</p>	<p>Within limitation of this standard. No solvent cement joints for network pipes</p>
<p>Lunden junction  Wye junction, (1574, 1504)  Wye with 45deg. junction 1554(or 1544).150.100.45  SN16 bends 46 – 90 deg,</p>		<p>Strata Plastics</p>	<p>Local networks gravity wastewater connections, note limitations of using lunden junctions with pipe grade</p>

Product model/name	Image	Manufacturer/supplier	Specific limitation
<p>SN16 bends 5 – 45 deg (1571, 1501)</p> <p>Drop junction with access cap (1507)</p> <p>Drop junction with cut end (1506)</p> <p>SN16 Injection Moulded Rubber Ring Joint Reducing Junction</p> <p>SN16 Injection Moulded Rubber Ring Joint Plain Bend</p>			
<p>Wye junction with 45deg</p> <p>Wye junction</p>		<p>Hygrade</p>	<p>Local networks gravity wastewater connections</p>

Product model/name	Image	Manufacturer/supplier	Specific limitation
Wye junctions  Models: LJA ('Lunden' but can be used for wye applications), Z, DZ		TD plastics	All areas of local gravity networks
Moulded junction and 45-degree bend		Aquafit	Local networks gravity wastewater connections
SN16 Ecoplas pipe and fitting		Aquafit	Within limitation of this standard. No solvent cement joints for network pipes
Ecoplas Hydrotite drop junction		Aquafit	Local networks gravity wastewater
Ecoplas Gritted Saddle		Aquafit	Local wastewater network gravity connections: SN16 Gritted saddles specifically designed for connecting to large diameter earthenware or concrete pipes
SN16 pipe with encapsulated rubber ring		Plascorp	Within limitation of this standard. No solvent cement joints.

### 13.1.6 Polyethylene (PE) pipe including fabricated bends and tees

**Note:** The use of PE pipe for sizes **over 300mm in the water distribution network requires specific approval** from Watercare for the intended project on a case-by-case basis. The use of larger PE pipe sizes are generally accepted for wastewater pressure applications.

#### **General requirements**

- a) For local network systems: pressure applications the minimum pressure rating shall be PN12.5 (networks) and for gravity wastewater minimum SDR17, SN16 pipe shall be used.  
**Note:** SN16 is typically used in developments and in the road corridor where temporary works and future road maintenance can cause pipe to deform.
- b) For transmission systems: For pressure pipe the minimum pressure rating shall be PN16 and for gravity wastewater minimum SDR17, SN16 pipe shall be used.  
**Note:** SN16 is typically used in developments and in the road corridor where temporary works and future road maintenance can cause pipe to deform.
- c) Any horizontally directionally drilled pipe shall be minimum SDR11.
- d) All PE pipe > 63mm OD shall be PE100RC.
- e) Polyethylene pipe for pressure applications shall be manufactured to AS/NZS 4130.  
**Note:** Striped service identification colour is acceptable where PE100RC is specified.
- f) Polyethylene pipe for gravity sewer applications shall be manufactured to AS/NZS 5065
- g) Polyethylene compounds for the manufacturing of pressure pipe and fittings shall comply with AS/NZS 4131 and PIPA POP004.
- h) All PE pipes shall be manufactured from new material. Re-worked material shall not be used in the manufacture of the pipe.
- i) Any component or lubricant in contact with the water supply shall comply with AS/NZS 4020.
- j) Pipe shall be supplied batched:
- of the same diameter
  - of the same wall thickness
  - the same marking
  - manufactured on the same machine
  - manufactured from the same base resin
  - master batch shall not be added to base resin by the pipe manufacturer
- k) Flange requirements refer to [section 13.4](#), and:
- All PE stub flanges shall conform to the requirements of ISO 9624. The SDR and PN rating of PE stub flanges shall be the same as the PE pipeline
  - PE flange connection with fitting that has mismatched flange drilling patterns may also be achieved by the use of a PE reduced spigot flange adaptor (“slim flange”) conforming and tested to AS/NZS 4129. The flange on such a fitting must still comply with AS/ISO 9624
- l) PE Bends and Tees:
- Where factory manufactured moulded bends or tees are not available short bends or tees shall be formed from mitred segments of the same material as the pipe, welded together in a quality-controlled factory environment by manufacturers with a recognised independently certified system to AS/NZS 4129. Unless specifically designed otherwise the maximum deflection angle at any mitre shall not exceed 18 degrees
  - The SDR and PN rating of PE bends and Tees shall be the same as the PE pipeline. Where heavier wall pipe is required to fabricate the fitting (to maintain the pressure rating of the pipeline) the spigot end of the pipe shall be machined to match the wall thickness and OD of the pipeline
  - The ends of bends and fittings shall have straight sections of at least 1.5 pipe diameters to facilitate welding on site

### Quality Control

- a) All products shall be marked in accordance with the conformity assessment body’s requirements.
- b) Pipe for pressure applications shall have product certification (ISO Type 5) to AS/NZS 4130.
- c) Pipe for gravity applications shall have product certification (ISO Type 5) to AS/NZS 5065.

d) Certification of compliance with AS/NZS 4020 for water applications.

**Procurement schedule**





Minimum standard required	Design specific requirements	Supplier submission
Application use description		
Nominal diameter		
Internal diameter		
SDR rating		
<u>Gravity:</u> Minimum SDR17		
<u>Pressure class:</u> Networks minimum PN12.5 Transmission minimum PN16		
Pipe >63mm diameter shall be PE100		
<b>Manufacturing standards:</b> AS/NZS 4130 and AS/NZS 4131 as or AS/NZS 5065 for gravity sewer as implemented by <a href="#">section 13.1.6</a>		
AS/NZS 4020 compliance (if for water)		
Pipe branding		
Pipe length		
Pipe ovality minimum OD tolerance		
Pipe ovality maximum OD tolerance		
Minimum pipe wall thickness		
Product and Test certificates		
<b>Delivery inspection</b>		
Average pipe wall thickness of 6 points equally spread around the pipe circumference		
Reversion: strong / clearly visible /not noticeable		
Damage inspection < 10% of wall thickness		

**Accepted products**

Product model/name	Manufacturer/supplier	Specific limitation
Pipe	Asmuss	Within limits of this standard. Fittings and pipe to be matched – refer to the construction standard. General acceptance up to 300mm
Poliplex	Iplex	Within limits of this standard. Fittings and pipe to be matched – refer to the construction standard. General acceptance up to 300mm
Pipe	Marley	Within limits of this standard. Fittings and pipe to be matched – refer to the construction standard. General acceptance up to 300mm
Pipe	Waters & Farr	Within limits of this standard. Fittings and pipe to be matched – refer to the construction standard. General acceptance up to 300mm
Pipe	RXP-aliasis	Within limits of this standard. Fittings and pipe to be matched – refer to the construction standard. General acceptance up to 300mm
Pipe	Mill-pro	Within limits of this standard. Fittings and pipe to be matched – refer to the construction standard. General acceptance up to 300mm
Pipe	Enviro PE	Within limits of this standard. Fittings and pipe to be matched – refer to the construction standard. General acceptance up to 300mm
Pipe PR & PKS plus profile	Hynds PKS	Wastewater gravity systems. All sizes by design.
Pipe / Spiral wound PE pipe	Infrapipe	Wastewater gravity systems. All sizes by design.
CivilBoss	Waters & Farr	Wastewater gravity systems. All sizes by design.

### ***Fabricated spigot fittings***

Product model/name	Image	Manufacturer/supplier	Specific limitation
Simona PE moulded range		Simona/Plasson	Injection moulded. General acceptance up to 300mm
Plastitalia PE stub flange		Plastitalia	General acceptance up to 300mm

Product model/name	Image	Manufacturer/supplier	Specific limitation
Fusion PE moulded spigot range		Fusion	General acceptance up to 300mm
Hiflo Hydrant Tee		Strata Plastics	Fire hydrant installations on PE pipe 125mm and 180mm
Agru PE moulded spigot range		Agru	Fire hydrant installations on PE pipe 125mm and 180mm
Agru stub flanges		Agru	General acceptance up to 300mm
NTG PE butt weld fittings		NTG Plastik	General acceptance up to 300mm
PE624 PE/PVC Adaptor		Solo Plastics	Wastewater gravity systems.

### 13.1.7 Polyethylene (PE) fittings other than fabricated bends and tees

Refer to [section 13.1.6](#) for spigot fittings

#### General requirements

- a) Minimum pressure rating shall be PN16.
- b) Fittings for pressure applications for use with polyethylene pipe shall be manufactured to AS/NZS 4129.
- c) Polyethylene fittings for gravity sewer applications shall be manufactured to AS/NZS 5065 or AS/NZS 4129.
- m) Fitting seals shall be EPDM complying with AS 1646 and AS 681.1 (EN 681-1).
- n) Polymeric coatings shall comply with AS/NZS 4158
- o) Electrofusion couplings and saddles:
  - Couplings and saddles must be the correct size for the pipe outside diameter
  - The fittings shall have a pressure rating no less than that of the pipe they are to be used to join
  - Couplings shall be bar coded for traceability and to provide information for preheat and fusion heating control and recording

- Tapping saddle fittings used with PE pipe must comply with AS/NZS 4129. Tapping into PE mains is limited up to 315mm nominal diameter. A Tee shall be installed on pipe sizes over this diameter
- p) Mechanical couplings and saddles:
  - PE compression fittings may be used only on PE80 up to 63mm only
  - Metallic mechanical couplings shall be used for repair purposes only (design life of plastic systems are +100 years, the component selection should support this which is not generally the case with metallic fittings)
  - Bronze tapping saddles intended for pipe material other than PE shall not be used with PE pipes
- d) Flange requirements shall be to [section 13.4](#).

### Quality Control

- a) Fittings shall have product certification (ISO Type 5) to AS/NZS 4129 and may be certified to AS/NZS 5065 for gravity sewer.
- b) Polymeric coatings shall have product certification (ISO Type 5) to AS/NZS 4158.
- c) Elastomeric joint seals shall have product certification (ISO Type 5) to AS 1646 and AS 681.1 (EN 681-1).
- d) Certification of compliance with AS/NZS 4020 for water applications.

### Procurement schedule

Minimum standard required	Design specific requirements	Supplier submission
Application use description		
Minimum product life of 100 years		
Nominal diameter		
Internal diameter range to fit pipe OD range		
To fit pipe SDR rating		
<u>Gravity:</u>		
Minimum SDR17		
Pressure class minimum PN16		
EPDM elastomeric seals to AS 1646 and AS 681.1 (EN 681-1).		
<b>Manufacturing standards:</b>		
AS/NZS 4129 as implemented by <a href="#">section 13.1.7</a>		
<b>Flanged fittings</b>		
Raised face B1		
BSEN1092 or AS/NZS4087 as per <a href="#">section 13.4</a>		
AS/NZS 4020 compliance (if for water)		
Product and Test certificates		

### Accepted products

Product model/name	Image	Manufacturer/supplier	Specific limitation
<b>Compression fittings</b>			
Compression fittings		Philmac	MDPE (PE80) use up to 63mm. Networks only
Compression fittings		Plasson	Compression for MDPE (PE80) use up to 63mm in networks only.
Compression fittings		Georg Fischer	Compression for MDPE (PE80) use up to 63mm in networks only.
Compression fittings S16		Supreme	MDPE (PE80) use up to 63mm. Networks only
Compression fittings		RXP - aliaxis	MDPE (PE80) use up to 63mm. Networks only
Compression fittings – easy fit		Hansen	MDPE (PE80) use up to 63mm. Networks only.
Connecto Plus Ultra		Irritec/WSP	MDPE (PE80) use up to 63mm. Networks only.
SAB Blue Seal		SAB/Hydroflow P&I	MDPE (PE80) use up to 63mm. Networks only.
<b>Electro-fusion fittings</b>			
Electro-fusion (Frialen)		Friatec	Complete range

Product model/name	Image	Manufacturer/supplier	Specific limitation
Electro-fusion		Monoline	Complete range
Electro-fusion		Agru	Complete range
Electro-fusion		Plasson	Complete range
Electro-fusion (Elgef+)		Georg Fischer	Complete range
Electro-fusion		Plastitalia	Complete range
Electro-fusion		Fusion	Complete range
<b>Tapping saddles (PE mechanical)</b>			
Tapping saddle		Philmac	PE mechanical, up to 110mm main, PN16. Compression off-take up to 63mm
Tapping saddle (Plassaddle)		Plasson	PE mechanical 63mm up to 180mm main, PN16. Compression off-take up to 63mm
Tapping saddle		RXP - aliaxis	PE mechanical, up to 63mm main, PN16 Compression off-take up to 63mm -
Tapping saddle (Elgef+) 684C, 654		Georg Fischer	PE mechanical up to 160mm main, PN16 Compression off-take up to 63mm
4N – PE option (including tapper accessory)		Stockbrands	PE mechanical up to 300mm main, PN16
<b>Tapping saddles (Electrofusion)</b>			

Product model/name	Image	Manufacturer/supplier	Specific limitation
Tapping saddle (Electro-fusion)		Plasson	PE electro-fusion up to 250mm main, PN16.
Tapping saddle (Electro-fusion)		Friatec	PE electro-fusion up to 315mm main, PN16. Depending on application.
Tapping saddle (Electro-fusion)		Monoline	PE electro-fusion up to 225mm main, PN16.
Tapping saddle (Electro-fusion)		Agru	PE electro-fusion up to 315mm main, PN16
Tapping saddle (Electro-fusion)		Georg Fischer	PE electro-fusion up to 315mm main, PN16
Tapping saddle (Electro-fusion)		Plastitalia	PE electro-fusion up to 300mm main, PN16
Tapping saddle (Electro-fusion)		Fusion group	PE electro-fusion up to 225mm main, PN16.
<b>Metallic tapping saddles (Mechanical for repair only)</b>			
WAGA Multi/Saddle		Georg Fischer	For pipe repairs only

Product model/name	Image	Manufacturer/supplier	Specific limitation
Haku 5250		Hawle	40mm to 315mm
VariTap		Wang	100 DN and 150 DN PE PN12.5 or higher
<b>Mechanical repair of PE (Repair only solution)</b>			
System 2000; Synoflex		Hawle	For pipe repairs. System 2000 can be considered as an alternative to electrofusion welding where appropriate for new installations.
WAGA (end restraint model)		Georg Fischer	For pipe repairs only
Aquagrip; Aquafast; Ultragrip		Viking Johnson	For pipe repairs only
621,623,624 and Support Bush 05		AVK	For pipe repairs only

Product model/name	Image	Manufacturer/supplier	Specific limitation
Xcel restraint joint		Daemco	For pipe repairs only  (Flange adaptors can be used for new connections to valves)

### 13.1.8 Glass reinforced plastic (GRP/FRP) pipe and fittings

#### General requirements

- GRP for pressure and non-pressure pipes for trenching applications shall be manufactured by filament wound or centrifugal casting process to ISO 23856.
- A minimum ring stiffness of SN10 (10000) under typical gravity system applications shall be used, unless otherwise specified or required for a specific installation methodology.  
**Note: SN16 is typically required for trenchless installations.**
- GRP for pressure and non-pressure pipes using pipe jacking techniques shall be manufactured by filament wound or centrifugal casting process to ISO 25780.
- For pipe jacking applications, pipe stiffness and jacking force shall be determined based on installation conditions and confirmed before procuring any pipe.
- Minimum compressive strength for GRP jacking pipes shall be 90MPa
- Centrifugal casting may be preferred in some instances due to manufacturing settings and to add specific linings to the pipe for different lining characteristics.
- Pipe shall be manufactured to achieve a 100-year design life
- Network applications shall have a minimum pressure rating of PN12. Transmission application shall have a minimum pressure rating on PN16
- Any component or lubricant in contact with the water supply shall comply with AS/NZS 4020.
- Maximum long-term deflection shall not exceed 5%.
- Pipe lengths of minimum 6m in length is preferred.
- Joint seals shall be EPDM complying with AS 1646 and AS 681.1 (EN 681-1).

#### Quality Control

- a) All products shall be marked in accordance with the conformity assessment body's requirements.
- b) Elastomeric joint seals shall have product certification (ISO Type 5) to AS 1646 and AS 681.1 (EN 681-1).
- c) Certification of compliance with AS/NZS 4020 for water applications.
- d) GRP for pressure and non-pressure pipes for trenching applications shall have product certification (ISO Type 5) to ISO 23856.
- e) GRP for pressure and non-pressure pipes using pipe jacking techniques shall have product certification (ISO Type 5) to ISO 25780.

#### Procurement schedule

Minimum standard required	Design specific requirements	Supplier submission
Application use description		
Nominal diameter		
Internal diameter		
External diameter		
Pipe lengths min 6m		

Minimum standard required	Design specific requirements	Supplier submission
<b>Pressure class:</b> PN12 – for all Networks pressure, or PN16 – for all Transmission pressure, or SN16 – for all gravity (trenched) SN rating and jacking force for GRP jacking pipes to be determined by design		
<b>Manufacturing standards:</b> ISO 23856 or ISO 25780 as implemented by this section		
<b>Joints:</b> Spigot and socket		
Product and Test certificates		

### Accepted products

Product model/name	Manufacturer/supplier	Specific limitation
*various*	Armatec	Within limits of this standard and design loads
Flowtite	Flowtite	Within limits of this standard and design loads
Superlit	Superlit Industries	Within limits of this standard and design loads
Hobas	Hobas	Within limits of this standard and design loads
Subor	Maskell	Within limits of this standard and design loads

## 13.1.9 Spiral welded steel pipe

### General requirements

- a) The normative compliance standard is AS 1579 for steel shell manufacture process and tolerances.
- b) Steel shall be manufactured to AS/NZS3678 or AS/NZS 1594 and demonstrate to meet the requirements of AS 1579.
- c) Pipe shall be manufactured with socket and spigot joints for fillet welding, unless otherwise specified.
- d) Any correction to formed steel shall be done by pressure and not by hammering.
- e) Manual welding shall be completed to AS/NZS 3992 and as required by the Watercare General Mechanical Construction Standard, Section 2.6.
- f) Edge preparation shall be carried out as per the relevant welding procedure. Missed welds shall be V-edge prepared a minimum of 2½ times the width of the weld on either side of the stop-start or further as determined by an ultrasound test result. The overlap shall be completed by manual welding across the prepared length. The end crater shall be filled by back-stepping at least 15mm at the end of the weld. Where there is no ability to back-step, the weld shall be grinded back a minimum of 25mm from the start of the external weld stop until 25mm past the internal weld stop before cleaning, preparing and re-welding the pipe.

- g) Cement mortar lining shall conform to AS 1281. Testing of concrete to NZS 3104 and NZS 3112.1.
- h) A test hole shall be formed in the socket end of all pipes DN700mm and over for spigot and socket pipes. The test hole shall be drilled with its centre line 15mm from the end of the pipe and tapped Rc 1/8" (BS21) using the tapered form of the thread as set out in BS21 or a parallel hole (Rp 1/8") that can be securely fitted with a BSP tapered thread with the following provisions:
- The gauge length shall be taken as the depth to gauge diameter measured from inside the pipe shell
  - The gauge length shall be 4 3/8 turns of thread (4.0mm) +/-1 thread (0.9mm)
  - The gauge diameter shall be 9.73mm

Threads shall be formed only after all operations likely to cause distortion, corrosion, or build-up of foreign material have been carried out. Once completed the test holes shall be filled with a rust inhibiting grease.

- i) A pipe identification number, to which plate details, manufacturing date quality control and source material can be related, shall be stencilled on the outside of the socket end of the pipe adjacent to the test hole with non-toxic permanent paint. If there is no test hole, the number shall be stencilled by the end of the spiral weld.
- j) Lining repair on pipe for the purpose of wastewater shall be done with a suitably resistant product such as MasterEmaco S 5400 (Emaco Nanocrete R4), Calcium Aluminate or similar accepted.
- k) Pipe external coatings (if specified) shall comply with AS 4321 if fusion bonded polyethylene. The specific performance requirement shall be stated as part of the design for the pipe service.
- l) For water applications any surface in contact with the water shall comply with AS/NZS 4020.
- m) Exterior tape coating applications of prefabricated polyolefin tapes shall comply with American Water Works Association Standards AWWA C225, AWWA C214 and AWWA C209 as applicable to the manufacturing method and tape type. Tape shall terminate at 150 mm for spigots and 100 mm for sockets from the pipe end.
- n) **The outside diameters shall standard to ISO 559 or ISO 4200. Pipe wall thickness may be increased in accordance with the specific design. Standardised dimensions are provided in the following table:**

Pipe shell					Ends	Pipe length			Preferred Joint Type	Concrete Lining				Setbacks			Min Preferred Type <sup>3</sup> deflection Joint (deg)
DN	Ds	Ts <sup>1</sup>	Tos <sup>1</sup>	Tc <sup>2</sup>	A	Eo	PE/LL	S & S		Di	Tc	Tol	Idt	Es Spigot	Ec Socket	Ete	
(mm)	(mm) O.D	(mm) tw	(mm)	(mm)	(mm)	(mm)	(m)	(m)	(mm) I.D	(mm)	(mm)	(mm)	(mm)	(mm)	(mm)	(mm)	
100	114	4.8	±0.25	±4	0	0	6	N/A	PE	86.4	9	±3	±7	0	0	180	0
150	168	5	±0.25	±4	8	16	9	9	SSJ	140	9	±3	±7	0	30	125	3
200	219	5	±0.25	±4	8	16	9	9	SSJ	191	9	±3	±7	0	30	125	3
250	273	5	±0.25	±4	10	20	9	9	SSJ	245	9	±3	±7	0	30	130	3
300	324	5	±0.25	±4	10	20	9	9	SSJ	296	9	±3	±7	0	30	130	3
350	356	5	±0.25	±4	10	20	9	9	SSJ	322	12	±4	±8	0	45	135	3
400	406	6	±0.27	±4	12	24	11.83	11.806	SSJ	370	12	±4	±8	0	45	135	3
450	457	6	±0.27	±4	12	24	11.83	11.806	SSJ	421	12	±4	±8	0	45	135	3
500	508	6	±0.27	±4	14	28	11.83	11.802	SSJ	472	12	±4	±8	0	45	140	3
600	610	6	±0.27	±4	16	32	11.83	11.798	SSJ	574	12	±4	±8	0	70	150	3
700	711	6	±0.27	±4	19	38	11.83	11.792	SSJ	675	12	±4	±8	0	70	155	3
750	762	8	±0.29	±4	22	44	11.83	11.786	SSJ	722	12	±4	±8	0	70	165	3
800	813	8	±0.29	±4	22	44	11.83	11.876	SSJ	765	16	±4	±8	50	110	165	3
900	914	8	±0.29	±4	25	50	11.83	11.87	SSJ	866	16	±4	±8	50	110	175	3
1000	1016	10	±0.32	±6	30	60	11.83	11.77	SSJ	964	16	±4	±10	50	110	190	3
1200	1219	10	±0.32	±6	34	68	11.83	11.762	SSJ	1167	16	±4	±10	85	140	200	3
1400	1422	10	±0.32	±6	35	70	11.83	11.76	SSJ	1364	19	±4	±10	85	140	205	3
1600	1626	12	±0.36	±6	38	89	11.83	11.741	BSJ	1564	19	±4	±10	50	200	230	3
1800	1829	12	±0.36	±6	35	100	11.83	11.73	BSJ	1767	19	±4	±10	85	200	250	3
1900	1981	12	±0.36	±6	35	110	11.83	11.72	BSJ	1919	19	±4	±10	85	220	270	3
2000	2159	16	±0.55	±6	38	115	11.83	11.715	BSJ	2071	28	±4	±10	85	220	280	3

DN	= nominal diameter	PE	= plain ended
Ds (O.D)	= outside diameter (steel)	LL	= laid length
Ts	= thickness of pipe steel	S & S	= spigot and socket
Tos	= tolerance on steel thickness	Di (I.D)	= internal diameter (concrete lining)
tc	= tolerance for circumference	Tc	= thickness of concrete lining
Eo	= length of straight-line entry	Tol	= tolerance on concrete lining thickness
Ete	= minimum set back of external coating or for tape coating 150mm for spigots and 100mm for sockets	Ec	= set back of concrete or paint lining at socket end
Es	= set back of concrete or paint lining at spigot end	Idt	= internal diameter tolerance
SSJ	= Spigot and socket joint	BSJ	= Ball and socket joint

<sup>1</sup> The nominated steel thickness is the minimum. Specific design may require a greater steel thickness (including thicknesses of up to 16mm with Tos  $\pm 0.55$ mm).

<sup>2</sup> This is a target tolerance, not a binding tolerance. AS 1579 allows +/- 0.5% of circumference.

<sup>3</sup> For the purpose of manufacturing the deflection angle tolerance is set as a minimum.

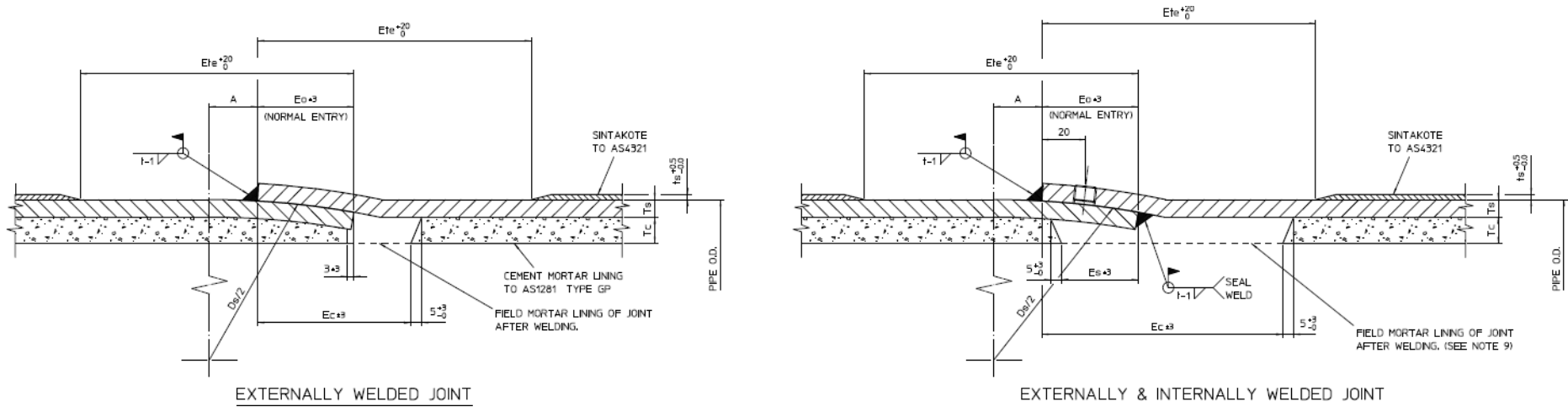

Figure 1: Spigot and socket joint illustration.

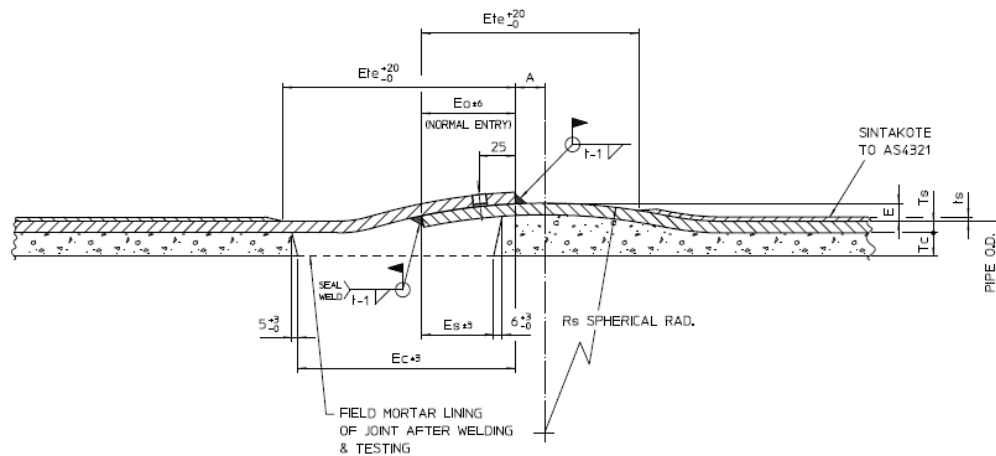

Figure 2: Ball and socket joint illustration.

### Quality Control

- a) Product shall be marked in accordance with the conformity assessment body's requirements.
- b) Steel material test certification to AS/NZS 3678 or AS/NZS 1594.
- c) Polymeric coatings (where applicable) shall have product certification (ISO Type 5) to AS/NZS 4158.
- d) Fusion bonded polyethylene coating (where applicable) shall have product certification (ISO Type 5) to AS 4321
- e) Certification of compliance with AS/NZS 4020 for water pipes.
- f) Routine testing:

Routine testing:	Test	Frequency
	Batch number relating to pipe numbers	Per plate batch
	Materials testing report – metallurgical compliance.	Per plate batch
	Materials testing report – material properties compliance.	Per plate batch
	<b>Destructive testing (optional to NDT)</b> <ul style="list-style-type: none"> <li>• Bend test: no crack or defect &gt; 1.5mm</li> <li>• Nick break test: no cracks, slag, no lack of penetration or fusion, spherical discontinuity ≤ 2% wall thickness or any discontinuity ≤ 1.5mm is acceptable.</li> <li>• Tensile test: &gt; Min. Tensile strength. no cracks, slag, no lack of penetration or fusion, spherical defect up to max 2%, any defect not exceeding 1.5mm Ø</li> </ul>	Weld Testing 5m of weldment shall be tested at start then per 900m or every 100 pipes of 6m length
	<b>Non-destructive testing (optional to destructive testing)</b> Ultrasonic or radiographic (X-ray) testing certified by recognised organisation	Weld Testing 5m of weldment shall be tested at start then per 900m or every 100 pipes of 6m lengths <b>Note:</b> all manufactured bends shall be radiographically (X-ray) tested
	Hydrostatic pressure test to AS 1579 Appendix F.	Every pipe
	Pipe joint deflection	One pipe deflection test per pipe size as a minimum and then 1 per 100 pipes thereafter
	Concrete lining	NZS 3104 – Batch records available on request NZS 3112.1 – Batch test records available on request
	Concrete lining finish: cracks < 0.8mm, max 50% depth of lining, no pocket, lumps or voids	Every pipe
	Tape wrapping	As specified by AWWA and reported per pipe order batch
	Fusion bonded polyethylene	As specified by AS 4321

### Procurement schedule

Minimum standard required	Design specific requirements	Supplier submission
Application use description		
Pipe nominal diameter		

Minimum standard required	Design specific requirements	Supplier submission
Pipe outside diameter		
Pipe wall thickness (minimum as set by this standard)		
Concrete lined (normative)		
External coated Polyken wrapping (normative). Refer to <a href="#">section 13.10.1</a>		
Internal epoxy coated to AS/NZS 4158 - Design specific performance to be specified. Refer to <a href="#">section 13.10.2</a>		
External epoxy coated to AS/NZS 4158 - Design specific performance to be specified Refer to <a href="#">section 13.10.2</a>		
External fusion bonded polyethylene coated to AS 4321 – Design specific performance to be specified		
<b>Manufacturing standards:</b> AS 1579 as referenced in <a href="#">section 13.1.9</a> within tolerances.		
<b>Joints</b> Spigot and socket, or Butt weld prepared, or Flanged (Refer <a href="#">section 13.4</a> )		
<b>Length</b> Minimum length 12m per pipe		
Product and Test certificates		

#### 13.1.9.1 Accepted products

Product model/name	Image	Manufacturer/supplier	Specific limitation
Sintakote		SteelMains	Excludes SintaJoint (non-welded rubber ring joint). SintaJoint requires specific approval.

### 13.1.10 Stainless steel pipe

#### General requirements

- Pipe and fittings shall be manufactured to AS 5200.053.
- Pipe and fittings shall be stainless steel 316L grade.

- c) Minimum pressure rating shall be PN16.

**Quality Control**

- a) All products shall be marked in accordance with the conformity assessment body's requirements.  
b) Product certification (ISO type 5) to AS 5200.053.

**Procurement schedule**

Minimum standard required	Design specific requirements	Supplier submission
Application use description		
Nominal diameter		
<b>Manufacturing standards:</b> AS 5200.053		
Minimum PN16 pressure rated		
<b>Joints</b> Refer flanges, <a href="#">section 13.4</a>		
Length		
Product and Test certificates		

**Accepted products**

Product model/name	Image	Manufacturer/supplier	Specific limitation
Europress press-fit system		Europress/Waterworks	Process plants
Mapress press-fit system (Geberit)		Asmuss Plastic Systems	Process plants
Hydropress press-fit system		Promains	Process plants

Product model/name	Image	Manufacturer/supplier	Specific limitation
RapidPress		The Metal Company	Process plants

### 13.1.11 Ductile iron castings for pipe, fittings and valves

#### General requirements

- The carbon present in the ductile iron shall be spheroidal and not flaked.
- Pipe and fittings sections shall be manufactured to AS 1831 Grade 400-12 or Grade 450-10.
- Typical valves and couplings for transmission applications or sizes over 250mm shall be manufactured to AS 1831 Grade 450-10 or higher. **Note:** A **high-risk local network** installation may require a material grade **higher than 400-12**

#### Quality Control

- All relevant physical, technical equipment and associated skill and knowledge will be audited, including actual manufacture of at least one heat following the associated testing and sampling process by an auditor with sufficient foundry and metallurgical knowledge on the following activities:

##### Laboratory equipment

- Carbon Equivalent (C.E.) machine to control melt analysis
- Optical Emission Spectroscopy (O.E.S.) or similar equipment to check melt chemistry and calibration
- Tensile testing equipment and calibration
- Hardness testing machines and calibration
- Metallographic microscopes, mounting and polishing equipment
- NDT Inspection tooling

##### Foundry melt production

- Melting and pouring equipment audit
  - Temperature control of metal in furnace and pouring stages
  - Process control of Spheroidizing treatment
  - Casting of test pieces and quarantine of product during testing
  - Actual mechanical testing and metallography on melts as routine procedures
  - Production of Test Certificates and conformance to standards and accreditation
  - Review past quality control records and non-conformance reports (if existing)
  - Availability of NDT technique for casting inspection
- Weld repair either artificially or structural are not accepted.
  - Plastic fillers to hide defects are not allowed.
  - Evidence of scabs, miss-runs, core or mould shift, metal penetration and swelling shall render the casting unfit.
  - Mechanical and chemical properties to AS 1831 measured on machined test pieces shall be prepared from either:

- Separately cast samples for fittings, pipe and valves ≤ DN300mm
  - Cast-on samples for valves and fittings >DN 300mm
  - Samples cut from a casting
- e) The nodularity of the graphite shall be minimum 90% Form V (slightly irregular spheroidal) and VI (spheroidal) for valves.
  - f) The nodularity of the graphite shall be minimum 80% Form V and VI for pipe. Pipe and fittings expected to withstand high loading and fatigue conditions shall have nodularity above 85%.
  - g) Test certificates to AS 1831 shall be provided together with the specific type test for the product.
  - h) Test certificates detailing the results of microstructure examination and mechanical results are required within 10 (ten) working days of the casting programme being completed and before shipping. This will include hydrostatic test result, hardness tests etc.
  - i) Frequency of test is per valve or fitting over 600mm (ISO Type 1a) and per batch for pipes and valves and fittings under 600mm (ISO Type 1b).

### 13.1.12 Ductile iron pipe and pipe fittings

#### **General requirements**

- a) Ductile iron casting shall comply with [section 13.1.11](#) of this standard.
- b) Ductile iron pipe and fittings shall be manufactured to AS/NZS 2280.
- c) Minimum pressure rating for pipe and pipe fitting shall be PN16.
- d) Capable of minimum flow velocity of 2m/s.
- a) Pipe shall be rubber ring jointed or flange cast. Refer to [section 13.4](#) for flanges (flange rated minimum PN16). Threaded flanges are not accepted.
- e) Polymeric coatings shall comply with AS/NZS 4158.
- f) Polyethylene sleeved coating (where not polymeric coated) shall comply with AS 3680.
- g) Pipe shall be sleeved as per f) or concrete lined to NZS 3122. Calcium aluminate cement (CaC) class concrete or a similar approved product shall be used for wastewater applications.
- h) Any component or lubricant in contact with the water supply system shall comply with AS/NZS 4020.

#### **Quality Control**

- a) Product certification (ISO Type 5) to AS/NZS 2280.
- b) Elastomeric joint seals certification (ISO Type 5) to AS 1646 and AS 681.1.
- c) Polymeric coatings shall have product certification (ISO Type 5) to AS/NZS 4158.
- d) Certification of compliance with AS/NZS 4020 for water use.
- e) Tensile test certification to AS 1391.
- f) Casting certification to AS 1831.
- g) Pipe or fitting markings shall include batch number or barcoded traceability to manufacturing verification.
- h) Routine testing:



<b>Routine testing:</b>	<b>Test</b>	<b>Frequency</b>
	Concrete lining test and records	NZS 3104 – Batch records available on request NZS 3112.1 – Batch test records available on request
	Material properties	Per batch and a minimum of 1 pipe shall be sampled from pipe supplied
	Dimensions	Each pipe / fitting
	Hydrostatic performance	Each pipe and fitting

### **Procurement schedule**

<b>Minimum standard required</b>	<b>Design specific requirements</b>	<b>Supplier submission</b>
Application use description		
Pipe or fitting		
Nominal diameter		
<b>Manufacturing standards:</b> AS 1831 as implemented by <a href="#">section 13.1.11</a> AS/NZS 2280 as implemented by <a href="#">section 13.1.12</a>		
Concrete lined (pipe). Class CaC, or similar, for wastewater applications		
External coating Epoxy or PE sleeve		
Joint method spigot and socket or flanged (no threaded flanges)		
Flange spot facing		
Minimum pressure classification PN16		
Pipe / fitting length		
Mass of fitting or per pipe length		
Product and Test certificates		

### **Accepted products**

<b>Product model/name</b>	<b>Image</b>	<b>Manufacturer/supplier</b>	<b>Specific limitation</b>
<b>Fittings</b>			
RLEF; FAZ; BEND; THAF; TAF		Gillies	Wastewater consider specific lining

Product model/name	Image	Manufacturer/supplier	Specific limitation
Sureflow		Viadux /Asmuss	Wastewater consider specific lining
AVK DI fittings		AVK	Wastewater consider specific lining
Derwent range		Derwent	Wastewater consider specific lining
Daemco		Daemco	Wastewater consider specific lining
Asmuss DI		Asmuss	Wastewater consider specific lining
Dimax		Dimax	Wastewater consider specific lining
Connector Vario		Hawle	Wastewater consider specific lining
Mallet		Mallet	Wastewater consider specific lining

Pipe		
Dimax Tyton (series)	Viadux / Asmuss / Reece	
Saint Gobain PAM	Viadux /Asmuss/P&I	

### 13.1.13 Seamless steel pipe and fittings

#### General requirements

- Pipe and fittings shall be manufactured to ASTM-A-106/333/335 and BS EN 10204.
- Minimum pressure rating shall be minimum schedule 10 or higher as required by the specific design.

#### Quality Control

- All products shall be marked in accordance with the conformity assessment body's requirements.
- Product certification (ISO type 5) to ASTM-A-106/333/335
- Manufacturing test certification to BS EN 10204.

#### Procurement schedule

Minimum standard required	Design specific requirements	Supplier submission
Application use description		
Nominal diameter		
<b>Manufacturing standards:</b> ASTM-A-106, ASTM-A-333 (low temp. app.), ASTM-A-335 (High temp. app.), and BS EN 10204		
Minimum Sch 10 pressure rated		
<b>Joints</b> Refer flanges, <a href="#">section 13.4</a>		
Length		
Product and Test certificates		

## 13.2 Valves

### 13.2.1 Gate valves 50mm diameter and greater

#### General requirements

- Ductile iron body casting shall comply with [section 13.1.11](#) of this standard.
- Valves shall have a minimum pressure rating of PN16.
- Spindle shall be non-rising.
- Spindle seal shall be non-asbestos gland box or O-ring that is accessible for replacement under full operating pressure.
- Valve operating torque shall not exceed 125Nm at the fully unbalanced allowable operating pressure, otherwise a gearbox shall be equipped, see [section 13.2.4](#).
- The valve operating direction shall be permanently marked on the valve, gearbox, spindle cap or hand-wheel.
- Refer to [section 13.4](#) for flanges.
- Threaded service valves shall be BSP connection
- Polymeric coatings shall comply with AS/NZS 4158.
- Applicable manufacturing standard is AS/NZS 2638.1 and .2
- Valve gate must raise clear of internal diameter of the valve when fully open.

For gate valves used in **water**:

- Valves shall be resilient seated
- Any component or lubricant in contact with the water supply shall comply with AS/NZS 4020
- The direction of rotation of input shaft shall be anticlockwise to close the valve. For installation on rider mains valves shall be clockwise closing.
- Valves shall be supplied with a spindle cap or hand-wheel as required, which shall be coated fusion bonded polymer complying with AS/NZS 4158. Colour shall be blue or black.

For gate valves used in **wastewater**:

- Valves shall be metal seated
- The direction of rotation of input shaft shall be clockwise to close the valve
- Valves for local network pressure systems shall be supplied with a triangular spindle cap, or otherwise square spindle cap, or hand-wheel for other applications which shall be coated fusion bonded polymer complying with AS/NZS 4158. Colour shall be red
- Valves that do not comply with AS/NZS 4020 shall be marked in the casting “NOT SUITABLE FOR WATER SUPPLY” or equivalent

### Quality Control

- Casting test certificates as per [section 13.1.11](#).
- Resilient seated gate valves shall have product certification (ISO Type 5) to AS/NZS 2638.2. For valve <80mm this certification is not available so must be reviewed to be in accordance with this standard or equivalent
- Metal seated gate valves shall have product certification (ISO Type 5) to AS/NZS 2638.1
- Polymeric coatings shall have product certification (ISO Type 5) to AS/NZS 4158.
- Elastomeric joint seals shall have product certification (ISO Type 5) to AS 1646 and AS 681.1 (EN 681-1).
- Certification of compliance with AS/NZS 4020 when used for water applications.
- All products shall be marked in accordance with the conformity assessment body's requirements.



### Procurement schedule

Minimum standard required	Design specific requirements	Supplier submission
Application use description		
Fluid type and nature		
<b>Valve type:</b> RSV – water Metal gate - wastewater		
Nominal diameter		
<b>Manufacturing standards:</b> AS 1831 as implemented by <a href="#">section 13.1.11</a> AS/NZS 2638.2 as implemented by <a href="#">section 13.2.1</a>		
AS/NZS 4020 compliance (if for water)		
<b>Protective coating:</b> AS/NZS 4158 or Altex specified		
Elastomeric seals to AS1646		
<b>Flanges:</b> Refer to <a href="#">section 13.4</a>		
Flange spot facing required (y/n)		



Minimum standard required	Design specific requirements	Supplier submission
Minimum pressure rated PN16		
<b>Valve operability/input/output</b>		
Installation orientation		
Maximum operating pressure of installation		
System test pressure		
Maximum flow velocity		
Closing direction		
Operation input (i.e. hand-wheel, actuator, etc.)		
Maximum handwheel diameter (if required – refer gearboxes for valves)		
Maximum operating torque for specified handwheel diameter is 356 N		
<p><b>Actuation:</b></p> <p><i>Gearboxes, required for input over 125 Nm unbalanced operation – attach procurement schedule from <a href="#">section 13.2.4</a></i></p> <p><i>Electric actuators – attach procurement schedule from <a href="#">section 13.13.5</a></i></p>		
<b>Valve specific information submittal</b>		
Valve manufacturer		
Country of valve manufacture		
Valve model		
Primary dimensions (or include drawings)		
Year of manufacture		
Serial number (supplied with each valve)		
Product and Test certificates		

**Accepted products**

Product model/name	Image	Manufacturer/supplier	Specific limitation
<b>Resilient seated – Water application</b>			

Product model/name	Image	Manufacturer/supplier	Specific limitation
Series 570-91		AVK	80mm to 250mm
Service valve (03/00)		AVK	50mm
E3		Hawle	50mm to 300mm
Service valve		Hawle	50mm
Gillies		Hygrade	50mm to 250mm
Sureflow 2570 (series 3)		AVK / Asmuss	80mm to 250mm
RSV gate		Daemco	50mm to 250mm
Service valve		Daemco	50mm

Product model/name	Image	Manufacturer/supplier	Specific limitation
Derwent		Derwent	50mm to 250mm
Hiwa RSV		Hiwa / Appletons	80mm to 250mm
Dimax		Reece	80mm to 250mm
<b>Metal seated – Wastewater application</b>			
Sureflow Figure 400		Viadux / Asmuss Water Systems	80mm to 200mm

Product model/name	Image	Manufacturer/supplier	Specific limitation
Series 580		AVK	80mm to 300mm
VGM16 & VGM35 Metal seated		Dobbie Dico	Up to 200mm
Derwent		Derwent MSGV	Up to 450mm

### 13.2.2 Butterfly valves – Double flanged

#### General requirements

- a) Ductile iron body casting shall comply with [section 13.1.11](#) of this standard.
- b) Butterfly valves shall comply with AS 4795.2 or an equivalent standard with specified testing to meet additional testing as set out in the table below:

Characteristic	Requirement	Test method described under AS4795.2	Standard (AS 4795.2) frequency of test	Additional Watercare requirements
<b>Type verification</b>				
Material properties	Materials	Review materials parts lists and compliance certificates against accepted materials	At any change in material	See <i>production verification on batch testing</i>
	Contamination of water	AS/NZS4020	At any change in material or 5 yearly	
	Elastomeric valve seal	AS 1646 Quality plan	At any change in elastomer. Available on request	See <i>production verification on batch testing</i>
	Seal suitability for service conditions	Review data sheets	At any change in elastomer	
	Elastomer hardness	AS1683	At any change in elastomer	
Design	Performance history	Review manufacturer's data, instructions, drawings, calculations and other relevant information such as material changes	Any change in design	<i>As defined in supply contract</i>
	Interchangeability of components			
	Installation			
	Head and flow operation			
	estimated operating life			
	Design calculations			
	End connections (flanges)	AS4087 or BS EN 1092-2	Any change in flange design	<i>As defined in supply contract</i>
	Welding	Category SP welding (AS/NZS 1554.1 or equivalent)	Any change in design	<i>Not applicable to valves with pressed or bolt-in seats</i>
	Castings	Visual examination and third-party verification	Any change in design or foundry	See <i>production verification on batch testing</i>
	External drainage holes	Design drawings	Any change in casting design	
	Face-to-face dimensions	BS EN 588 or ISO 5752	Any change in design	
Supports	Design drawings		Any change in design	

Characteristic	Requirement	Test method described under AS4795.2	Standard (AS 4795.2) frequency of test	Additional Watercare requirements
	Seal Shaft	Design drawings		Any change in design
	Shaft sealing and ingress	Design drawings		Any change in design
	Shaft bearings	Design drawings and bearing data sheet	Any change in bearing type or supplier	See <i>production verification on batch testing</i>
	End thrust	Design drawings	Any change in design	
	Input stops and torque limiting devices	Design drawings and visual examination	Any change in design	
	Position indicator	Design drawings and visual examination	Any change in design	
	Lockout devices	Design drawings and visual examination	Any change in design	
	Operation	Design drawings and visual examination	Any change in design	
	Spindle cap, spindle extension and key	Design drawings and visual examination and dimensional checks	Any change in design	See <i>production verification on batch testing</i>
	external spindle tube	Design drawings and visual examination and dimensional checks	Any change in design	
	Gearboxes	<b>Refer section 13.13.5</b>		
	Lifting devices	Design drawings	Any change in supplier	Any change in lifting design
	Fasteners	AS1111.1,.2,.3	Any change in supplier	See <i>production verification on batch testing</i>
Protective coatings	Coating effective for all internally wetted surfaces and non-corrosion resistant materials	AS/NZS4158	Any change in design, coating material, coating process or coating applicator	See <i>production verification on batch testing</i>
	Coatings on actuators and gearboxes	<b>Refer section 13.13.5</b>		
	Continuous immersion	AS/NZS4158	Any change in design, coating material, coating process or coating applicator	See <i>production verification on batch testing</i>
Type tests	Body strength	Test A	Each valve size, after any change in design, materials, suppliers, or place of manufacture	See <i>production verification on batch testing</i>
	Free end	Test B		
	Disc strength	Test C		
	Shaft strength	Test D		
	Valve operation	Test E		

Characteristic	Requirement	Test method described under AS4795.2	Standard (AS 4795.2) frequency of test	Additional Watercare requirements
	Sealing	Test F		
	Weld deposit seal	Test G		
<b>Production verification</b>				
Design	Standard critical dimensions	Design drawings	One valve per production batch	Batch testing for valves ≤600mm, every valve over 600mm
Freedom from casting defects	Structural and surface defects	Visual	Each valve	Valves ≤ 600mm one valve ultrasonic tested per production batch. All valves over 600mm to be ultrasonic tested for 0 casting voids
	<i>Body castings- (Watercare additional requirement)</i>	<i>Material analysis from cast-on sample bar Water care amendments to AS1831 that includes material composition, nodularity above 90%, Tensile and hardness testing (Watercare additional requirement)</i>		Valves ≤ 600mm one per production batch. All valves over 600mm test each valve
<i>Flange truing</i>	<i>Flange back end spot-facing within 2 degree tolerance</i>	<i>&gt;2 degrees</i>		Each valve
Travel stops	Correct positioning of disc in open and closed position	Adjustments and visual examination	Each valve	
Protective coatings	Continuous immersion	AS/NZS4158	Each valve	Holiday testing accepted
Production test	Coating	Test 1	Each valve	
	Body strength	Test 2	Each valve	
	Sealing	Test 3	Each valve	
	Reverse sealing	Test 4	Each valve	
	Disc strength		As required	Batch testing for valves ≤600mm, every valve over 600mm
	free end		As required	One valve per production batch
	Weld deposit seal	Test 5	Each valve	<i>Not applicable to valves with pressed or bolt-in seats</i>

Characteristic	Requirement	Test method described under AS4795.2	Standard (AS 4795.2) frequency of test	Additional Watercare requirements
	Valve componentry material test - (Watercare additional requirement)	Material analysis from batch per each component		One sample per batch representative of valve order supplied
Marking	Markings	Visual examination	One valve per production batch	
	Direction of closure of handwheels and caps			
Packaging	Suitable packaging	Manufacturer's specification	Each package	

- c) Any component or lubricant in contact with the water supply shall comply with AS/NZS 4020.
- d) Polymeric coatings shall comply with AS/NZS 4158 or recognised equivalent standard demonstrating suitable coating thickness and test methodology.
- e) Minimum pressure rating shall be PN16.
- f) Must accommodate under normal operation a nominal flow velocity of 4m/s.
- g) Valve operating torque shall not exceed 125Nm at the fully unbalanced allowable operating pressure for a handwheel diameter not exceeding 600mm; otherwise, a gearbox shall be equipped, see [section 13.2.4](#).
- h) Operation by hand wheel with gearbox, or actuator may be specified from additional section 13.2.4 and section 13.13.5.
- i) Refer [section 13.4](#) for flanges. Flange drilling may be to AS/NZS4087 or BS EN1092 with suitable joint detail and specified bolting torques.
- j) Valves shall be suitable for bi-directional flow and end of line use.
- k) Seat sealing arrangement shall be Seal-on-disc and single or double eccentric disc offset from the shaft. Concentric valves or rubber lined valves are not acceptable.
- l) The body seat surface shall be stainless steel grade 316 or approved equivalent.
- m) Shaft connection shall be keyed using a taper pin on a partially milled flat groove on the edge of the shaft/ Straight pins through the centre of the shaft.
- n) Valves shall be provided with a suitable spindle lockout device independent from the handwheel and gearbox.
- o) Component specific requirements:

Component	Material	Grade	Standard
Body	Ductile iron	65-45-12; 500-7	AS1831; ASTM A536; EN1563 and as amended by section 13.1.11
Shaft & shaft extension	Stainless steel	316 or suitable alternatives such as Grade 431 or 630	ASTM A276; ASTM A564 / BS EN 10088-5 or recognised equivalent
Shaft collar & bearing	Bronze, PTFE, Nylatron or better polymer	DZR Bronze, Self-lubricating PTFE and Nylon	ASTM763 or required by AS 4795.2 and equivalents

Component	Material	Grade	Standard
Shaft seal	Elastomer	EPDM O-ring, V-type packing	AS 1646 or recognised equivalent
Disc	Ductile cast iron	65-45-12; 500-7	AS1831; ASTM A536; EN1563 and as amended by section 13.1.11
Body seat	Stainless steel or Nickel-copper alloy	316	ASTM A276; BS EN 10088-5 or recognised equivalent
Disc to shaft fixing	Stainless steel	A4/316	ASTM A276, ASTM F594; BS EN 10088-5 or recognised equivalent
Seals & O-ring	Elastomer	EPDM, NR, NBR	AS 1646 or recognised equivalent
Fasteners	Stainless steel	A4/316	ASTM A276 / BS EN 10088-5 or recognised equivalent
Seal retaining rings	Stainless steel	316	ASTM A276 / BS EN 10088-5 or recognised equivalent
Lifting eyebolts	Hot dip galvanised steel or cast into body		AS 1214/ISO 1459 or recognised equivalent
Handwheel	Polymeric coated ductile iron	400-15; 65-45-12; 500-7	AS 1831 / ASTM A536 or recognised equivalent

**Quality Control**

- a) Casting test certificates as per [section 13.1.11](#).
- b) Butterfly valves shall have product certification (ISO Type 5) to AS 4795.2 or equivalent with additional testing
- c) Polymeric coatings shall have product certification (ISO Type 5) to AS/NZS 4158 or equivalent.
- d) Elastomeric joint seals shall have product certification (ISO Type 5) to AS 1646 and AS 681.1 (EN 681-1 or equivalent).
- e) Certification of compliance with AS/NZS 4020 (required for water applications) or equivalent.
- f) Component material batch test demonstrating compliance with the applicable standard.



**Procurement schedule**

Minimum standard required	Design specific requirements	Supplier submission
<b>Valve service environment</b>		
Application use description		
Fluid type and nature		

Minimum standard required	Design specific requirements		Supplier submission
Minimum pressure rated PN16			
Maximum operating pressure			
System test pressure			
Nominal flow velocity			
Maximum flow velocity under emergency			
Installation orientation ( <i>May require shaft keyway to be cut</i> )			
<b>Valve configuration/features</b>			
Nominal diameter (mm)			
Flange drilling configuration	AS/NZS4087		
	BS EN 1092		
Special protective coating (Altex specification)			
Exterior paint colour			
Flange face coated/uncoated			
Shaft lock-out device			
<b>Valve operability/input/output</b>			
Maximum handwheel diameter 600mm (if required – refer gearboxes for valves)			
<p><b>Actuation:</b> Gearboxes, required for input over 125 Nm unbalanced operation – attach procurement schedule from <a href="#">section 13.2.4</a></p> <p>Electric actuators – attach procurement schedule from <a href="#">section 13.13.5</a></p>			
<b>Valve specific information submittal</b>			
Valve model			

Minimum standard required	Design specific requirements	Supplier submission
Shaft maximum input torque		
Unseating torque at rated pressure		
Total assembled mass		
<b>Testing and quality assurance</b>		
Product and Test certificates as specified by supply contract		
<b>Shipping requirements</b>		
Shipping details		

### Standardised products

Product model/name	Image	Supplier	Specific limitation
AVK 756 series		Humes / Asmuss	Refer to Section 13.4 for acceptable flange patterns
Valmatic BFV2000 series		Asmuss	Refer to Section 13.4 for acceptable flange patterns
Ozkan		Hynds Water	Refer to Section 13.4 for acceptable flange patterns



### 13.2.3 Butterfly valves – Lugged or tapped flange

#### General requirements

- a) May be used up to 250mm only.
- b) Ductile iron body casting shall comply with [section 13.1.11](#) of this standard.
- c) Butterfly valves shall comply with AS 4795.1.
- d) Any component or lubricant in contact with the water supply shall comply with AS/NZS 4020.
- e) Polymeric coatings shall comply with AS/NZS 4158.
- f) Minimum pressure rating shall be PN16.
- g) Lugged butterfly valves shall be supplied with indexed studs.

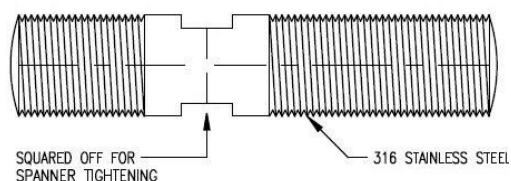

- h) The lugged or tapped spacing shall conform to the flange requirements.
- i) Must accommodate under normal operation a nominal flow velocity of 4m/s.
- j) Valve operating torque shall not exceed 125Nm at fully unbalanced allowable operating pressure, otherwise a gearbox shall be equipped, see [section 13.2.4](#).
- k) Operating handle, hand wheel or gearbox may be specified.
- l) Valves shall be suitable for bi-directional flow.
- m) Disc sealing arrangement shall be fully lined vulcanised rubber. Replaceable or loose liners are not accepted for water distribution applications (to be bonded to the body) but may be specified for treatment plant applications where required.
- n) Shaft connection shall be keyed using a taper pin on a partially milled flat groove on the edge of the shaft/ Straight pins through the centre of the shaft.
- o) Valves shall be fitted with a lockout device to the spindle
- p) Component specific requirements:

Component	Material	Grade	Standard
Shaft & shaft extension	Stainless steel	316	ASTM A276 / BS EN 10088-5 or recognised equivalent
Shaft collar & bearing (on both ends)	Bronze, PTFE or better polymer	DZR Bronze	As required by AS 4795.2
Shaft seal	Elastomer	EPDM O-ring, V-type packing	AS 1646 or recognised equivalent
Valve lining	Vulcanised rubber		
Disc	Stainless steel	316	ASTM A276 / BS EN 10088-5 or recognised equivalent
Disc to shaft fixing	Stainless steel	316	ASTM A276 / BS EN 10088-5 or recognised equivalent
Seals & O-ring	Elastomer	EPDM, NR, NBR	AS 1646 or recognised equivalent

Component	Material	Grade	Standard
Fasteners	Stainless steel	316	ASTM A276 / BS EN 10088-5
Shaft operating lever	Stainless steel	316	ASTM A276 / BS EN 10088-5 or recognised equivalent
Handwheel	Polymeric coated ductile iron	65-45-12/400-15, 500-7	AS 1831 / ASTM A536 or recognised equivalent

### Quality Control

- Casting test certificates as per [section 13.1.11](#).
- Butterfly valves shall have product certification (ISO Type 5) to AS 4795.1.
- Polymeric coatings shall have product certification (ISO Type 5) to AS/NZS 4158.
- Elastomeric joint seals shall have product certification (ISO Type 5) to AS 1646 and AS 681.1 (EN 681-1).
- Certification of compliance with AS/NZS 4020.
- Component material batch test demonstrating compliance with the applicable standard.



### Procurement schedule

Minimum standard required	Design specific requirements	Supplier submission
<b>Valve service environment</b>		
Application use description		
Minimum service life 50 years		
Fluid type and nature		
AS/NZS 4020 compliance (if for water)		
Minimum pressure rated PN16		
Maximum operating pressure		
System test pressure		
Nominal flow velocity 4m/s		
Maximum flow velocity under emergency		
Bi-directional flow. End of line		
Installation orientation		
<b>Valve configuration/features</b>		
Nominal diameter (mm)		
Flanges to <a href="#">section 13.4</a>		
Protective coating to AS/NZS 4158 or Altex specified		
Exterior paint colour		

Minimum standard required		Design specific requirements	Supplier submission
Fully vulcanised rubber seal in body			
Liner bonded or loose			
<i>Shaft connection:</i> Keyed with taper pin, or Straight pins through the shaft centre			
Spindle lockout device			
Supplied with indexed studs – refer material grades in <a href="#">section 13.5</a>			
<b>Valve operability/input/output</b>			
Closing direction clockwise			
Maximum handwheel diameter 600mm (if required – refer gearboxes for valves)			
Maximum operating force on the handwheel is less than 356 N			
<b>Actuation:</b> <i>Gearboxes, required for input over 125 Nm unbalanced operation – attach procurement schedule from <a href="#">section 13.2.4</a></i> <i>Electric actuators – attach procurement schedule from <a href="#">section 13.13.5</a></i>			
<b>Manufacturing standards and component materials:</b>			
Valve body to AS 1831 as implemented by <a href="#">section 13.1.11</a>			
Ductile iron grade 450-10 or 500-7			
Testing frequency type 1a or 1b			
Valve body casting material sample bar, or batch test			
Min. required graphite nodularity			
AS 4795.2 as implemented by <a href="#">section 13.2.3</a>			
Shaft & shaft extension	Stainless steel		
Shaft collar & bearing (on both ends)	Bronze, PTFE or better polymer		
Shaft seal	Elastomer		
Valve lining	Vulcanised rubber		
Disc	Stainless steel		
Disc to shaft fixing	Stainless steel		

Minimum standard required		Design specific requirements	Supplier submission
Seals & O-ring	Elastomer		
Fasteners	Stainless steel		
Shaft operating lever	Stainless steel		
Handwheel	Polymeric coated ductile iron		
<b>Valve specific information submittal</b>			
Valve manufacturer			
Country of valve manufacture			
Valve model			
Primary dimensions (or include drawings)			
Year of manufacture			
Serial number (supplied with each valve)			
Shaft maximum input torque			
Unseating torque at rated pressure			
Total assembled mass			
Recommended installation support/mounting			
<b>Testing and quality assurance</b>			
Product and Test certificates			
<i>Additional QA evidence (identified where required):</i>			
Manufacturers Inspection and Test Plan (ITP) – Manufacturer to provide access for third party inspection	<input type="checkbox"/>		
Inspection & Test Factory/Foundry Results	<input type="checkbox"/>		
Factory body hydrostatic pressure test	<input type="checkbox"/>		
Valve fully assembled closed drop tight pressure test	<input type="checkbox"/>		
Valve to be fully assembled in factory prior to shipping	<input type="checkbox"/>		
Assembled valve/actuator settings test	<input type="checkbox"/>		
<b>Shipping requirements</b>			
Shipping details			
Packing/Protection			
Identification			
Inspection on delivery			

### Standardised products

Product model/name	Image	Supplier	Specific limitation
AVK 76 series		AVK / Asmuss	Water networks to isolate air valves (for pipes up to 630mm nominal bore)
Z014A		Ebro Armaturen	Water networks to isolate air valves (for pipes up to 630mm nominal bore);  Treatment plants = by design
Z014B (Vulcanised liner)		Ebro Armaturen	Treatment plants = by design  (Severe conditions and vacuum applications)

### 13.2.4 Gearboxes for valves

#### General requirements

- The gearbox mounting flange shall conform to ISO 5211.
- The gearbox type shall be slotted lever or indirect lever with a travelling nut operating the disc shaft via a crank lever and worm gear. The complete operating mechanism shall be housed in a leak proof enclosure.
- The method of attachment of gears, worms and wheels to shafts shall be by key and keyway. Roll or split/taper pins are not acceptable.
- Mechanical operation shall be self-locking in all positions of the valve disc.
- Handwheel shall be 600mm maximum in diameter and marked to indicate direction of closing.
- Closing of the valve shall be by clockwise operation for water and anticlockwise for wastewater operation of the handwheel when viewed from the top of the handwheel. Note: All butterfly valves are to close in clockwise direction.
- The manual gearbox shall be designed to produce the required operating torque with a maximum rim pull of 356N on the handwheel. The position stops and all other components must be designed to withstand a rim pull of at least 890N for a handwheel.

- h) Direction arrows shall be clearly visible and permanently on the handwheel.
- i) Adjustable stops shall be provided to prevent over travel of the valve disc in either direction.
- j) The gearbox shall be IP65 or better for valves installed above ground surface and minimum IP67 rated for valves installed below ground or in chambers; capable of operation without detriment to its mechanical function when it is immersed in water.
- k) Gears shall have a hardness of 58-62 Rc.

**Quality Control**

- a) Polymeric coatings shall have product certification (ISO Type 5) to AS/NZS 4158.
- b) Elastomeric joint seals shall have product certification (ISO Type 5) to AS 1646 and AS 681.1 (EN 681-1).

**Procurement schedule**

Minimum standard required	Design specific requirements		Supplier submission
Application use description/valve to be matched with			
Gearbox type: Slotted lever or indirect lever with travelling nut – operating geared lever or worm gear			
IP rating	IP65		
	IP67 or better		
<b>Protective coating:</b> AS/NZS 4158 or Altex specified			
<b>Input flange – ISO 5211</b>			
Flange spot facing			
Closing direction			
Maximum handwheel diameter 600mm			
Maximum input force 356 N			
Attachment of gears, worms and wheels to shafts shall be by key and keyway. Roll or split/taper pins are not acceptable			
Installation orientation			

Minimum standard required	Design specific requirements	Supplier submission
Gearbox manufacturer		
Country of manufacture		
Gearbox model		
Primary dimensions (or include drawings)		
Year of manufacture		
Serial number (supplied with each gearbox)		
Maximum output torque		
Maximum input torque		
Gearbox ratio		
Number of turns – (fully open to fully close)		
Total assembled mass		
Product and Test certificates		

### **Accepted products**

Product model/name	Images	Manufacturer/supplier	Specific limitation
Rotork IW, MTW		Rotork	Specified per application

## **13.2.5 Valve extension spindles**

### **General requirements**

- a) Applicable torque testing shall be certified to AS/NZS 2638 Part 1 Test J and Part 2 Test M or equivalent.
- b) Welding of spindles or components shall be in accordance with AS/NZS 1554.1.
- c) Cast iron or ductile iron extensions shall not be welded.
- d) Spindles shall be coated with a bonded polymeric coating or be supplied in stainless grade 316 in aggressive soils.

- e) Length supplied appropriate to the installation specification.

**Quality Control**

- a) Certification of maximum strength test torques to AS/NZS 2638.1 Test J and AS/NZS 2638.2 Test M or equivalent.  
b) Polymeric coatings shall have product certification (ISO Type 5) to AS/NZS 4158.

**Procurement schedule**

Minimum standard required	Design specific requirements	Supplier submission
Application use description		
Maximum input torque – design specified. (Minimum 356 Nm)		
Length of spindle		
Soil type (aggressive/non-aggressive)		
Spindle material		
Coating		
Product and Test certificates		

**Accepted products**

Product model/name	Image	Manufacturer/supplier	Specific limitation
Sureflow extension spindle		Asmuss	To product specified limitations
Valve extension spindle		Daemco / Promains	Valves up to 600mm

### 13.2.6 Control valves – Solenoid and piloted hydraulic actuated valves

#### General requirements

- a) Ductile iron body casting shall comply with [section 13.1.11](#) of this standard.
- b) Control valves shall comply with AS 5081 or AWWA C-530:12.
- c) Any component or lubricant in contact with the water supply shall comply with AS/NZS 4020.
- d) Polymeric coatings shall comply with AS/NZS 4158.
- e) Minimum pressure rating shall be PN16.
- f) Refer to [section 13.4](#) for flanges.

#### Quality Control



- a) Casting test certificates as per [section 13.1.11](#).
- b) Control valves shall have product certification (ISO Type 5) to AS 5081 or AWWA C-530:12.
- c) Polymeric coatings shall have product certification (ISO Type 5) to AS/NZS 4158.
- d) Certification of compliance with AS/NZS 4020.

#### Procurement schedule

Minimum standard required	Design specific requirements	Supplier submission
Application use description		
Control type		
<b>Manufacturing standards:</b> AS 5081 or AWWA C-530:12		
Fluid type and nature		
Nominal diameter		
<b>Protective coating:</b> AS/NZS 4158 or Altex specified		
<b>Flanges:</b> Refer to <a href="#">section 13.4</a>		
Flange spot facing		
Minimum pressure rated PN16		
Maximum inlet pressure		
Minimum inlet pressure		
Minimum operating outlet pressure required		
Outlet pressure at max flow		
Minimum continuous flow (l/s)		
Maximum continuous flow (l/s)		
Accuracy at minimum flow		
Installation orientation		
Pilot Control		

Minimum standard required	Design specific requirements	Supplier submission
Control (system)		
Limit switch assembly		
Power supply		
Failure mode of pilot – control indication		
Failure mode of main valve – control indication		
Position Indicator – manual, output or both		
Reverse flow inhibitor		
Pilot Setting - Supplier to advise based on Operating and Process Conditions		
Pilot Adjustment Range - Supplier to advise based on Operating and Process Conditions		
Country of manufacture		
Control valve model		
Pilot valve model		
Year of manufacture		
Serial number (on supply with each valve)		
Total assembled mass		
Recommended installation support		
Product and Test certificates		

**Accepted products**

Product model/name	Image	Manufacturer/supplier	Specific limitation
Model 700		Bermad	Must be design specified
Model 100		Cla Val	Must be design specified

### 13.2.7 Air release/vacuum valves for sewer applications

#### General requirements

- a) Applicable manufacturing standard is AS 4883.
- b) Refer to [section 13.4](#) for flanges.
- c) Valves shall be double acting (combination).
- d) Typical pressure rating shall be PN16 or as otherwise suitable to the specific design location but at least 1.25x the system test pressure.
- e) Connections may be threaded for 80mm but shall be flanged for all larger valves.
- f) O-Rings and seals shall be EPDM.
- g) The float shall be from High Density Polyethylene, Polypropylene or stainless steel.

#### Quality Control

- a) All products shall be marked in accordance with the conformity assessment body's requirements.
- b) Valves shall have product certification (ISO Type 5) to AS4883.
- c) Polymeric coatings shall have product certification (ISO Type 5) to AS/NZS 4158.

#### Procurement schedule

Minimum standard required	Design specific requirements	Supplier submission
Application use description		
Double acting (Release/Vacuum)		
PN16 rated, or Minimum 1.25x system test pressure		
Size (mm diameter)		
Connection type: Flanged (over 80mm) – specify flange drilling <a href="#">section 13.4</a> BS21 threaded		
Product and Test certificates		

#### Accepted products

Product model/name	Image	Manufacturer/supplier	Specific limitation
ARV-3N		AVFI	Up to PN16

Product model/name	Image	Manufacturer/supplier	Specific limitation
701/70		AVK	Transmission use (flange drilling). Up to PN16
SCF-RFP		Bermad (CSA)	Up to PN 16
RGX		Vent-o-mat	Transmission use Up to PN16
VM-800-S (and) VM-300-S		Val Matic / Asmuss	Min. PN10. Valve size shall be specific to venting requirement
ARI AD020; AD025L; AD026		ARI	Networks
Bermad C50-N, C50-G or C50-J series		Bermad / Deeco	Networks

### 13.2.8 Air release/vacuum valves for water supply

#### General requirements

- Applicable manufacturing standard is AS 4956.
- Any component or lubricant in contact with the water supply shall comply with AS/NZS 4020.
- Valves shall be double acting (combination).
- Minimum pressure rating shall be PN16; connections may be threaded for 80mm but shall be flanged for all larger valves.

- e) Refer to [section 13.4](#) for flanges.
- f) O-Rings and seals shall be EPDM. The float shall be from High Density Polyethylene, Polypropylene or Stainless steel. All other wetted areas shall be stainless steel grade 316 or Ductile Iron.

**Quality Control**



- a) All products shall be marked in accordance with the conformity assessment body's requirements.
- b) Valves shall have product certification to AS 4956.
- c) Certification of compliance with AS/NZS 4020 for water use application.
- d) Polymeric coatings shall have product certification (ISO Type 5) to AS/NZS 4158.

**Procurement schedule**

Minimum standard required	Design specific requirements	Supplier submission
Application use description		
Double acting (Release/Vacuum)		
PN16 rated		
Size (mm diameter)		
Connection type: Flanged (over 80mm) – specify flange drilling. Refer section 13.4 BS21 threaded		
AS/NZS 4020 compliant for water use		
Product and Test certificates		

**Accepted products**

Product model/name		Manufacturer/supplier	Specific limitation
RBX 2511 & 2521		Vent-o-mat	80mm to 150mm
ARC30		Bermad	Up to and including 50mm , on specific application approval on pipework smaller than network mains

Product model/name		Manufacturer/supplier	Specific limitation
Series 851/10		AVK	80mm to 150mm
DAV-MH		AVFI	80mm to 150mm
ARI AD043 and AD046		ARI	Networks
Gillies		Hynds	Transmission water pipeline use
Bermad C70 series		Bermad	Networks
Fox 3F RFP		CSA	Networks

### 13.2.9 Hydrant valves

#### General requirements

- a) Hydrant valves shall be 80mm NB.
- b) Ductile iron body casting shall comply with [section 13.1.11](#) of this standard.

- c) Hydrants shall be manufactured to NZS 4522.
- d) Valve flanges for network application shall be flanged to AS/NZS 4087.
- e) Flange facing shall be raised face B1.
- f) Polymeric coatings shall be to AS/NZS 4158 ).
- g) All hydrants shall be supplied as screw down type, tall pattern with allowable working pressure to 1,600kPa, with polyurethane cup washer, PTFE gland packing or O-ring sealing system.
- h) Hydrants shall be clockwise closing fitted with a standard removable spindle cap with dimensions as per NZS4522. Colour shall be blue.

### Quality Control

- a) All products shall be marked in accordance with the conformity assessment body's requirements.
- b) Casting test certificates as per [section 13.1.11](#).
- c) Polymeric coatings shall have product certification (ISO Type 5) to AS/NZS 4158.
- d) Any component or lubricant in contact with the water supply shall comply with AS/NZS 4020.
- e) Certification of testing performed as per NZS 4522.

### Accepted products

Product model/name	Image	Manufacturer/supplier	Specific limitation
Series 29		AVK	80mm diameter only (tall)
Gillies		Gillies	80mm diameter only (tall)
80BFH41X1		Promains	80mm diameter only (tall)

### 13.2.10 Gate valves smaller than 50mm – Water use only

Valves in this section **shall not be used** for water mains isolation, but **only for lot service connections or processes**. For network isolation purposes using gate valves, refer to [section 13.2.1](#).

### General requirements

- a) Valves shall be manufactured to AS1628 or BS 5154.
- b) All brass components shall be dezincification resistant (DR/DZR).
- c) Minimum pressure rating of PN16 with threaded end connections.

- d) Valves shall be clockwise closing and fitted with ductile or grey cast iron hand-wheel with polymeric coating. The hand-wheel shall have open spokes.
- e) The stem seal shall be replaceable under pressure and be either braided PTFE yarn or EPDM O-ring.

**Quality Control**

- a) All products shall be marked in accordance with the conformity assessment body's requirements.
- b) Certification of compliance with AS/NZS 4020.
- c) Product certification to AS1628 or BS 5154.

**Procurement schedule**

Minimum standard required	Design specific requirements	Supplier submission
Application use description		
Applicable valve manufacturing standard		
DZR brass or better		
Minimum PN16 rated		
Size (mm diameter)		
Threaded end connections, BS21		
PTFE or EPDM stem seal		
Polymeric coated handwheel or better		
AS/NZS 4020 compliant for water use		
Product and Test certificates		

**Accepted products**

Product model/name	Image	Manufacturer/supplier	Specific limitation
PN16 FH		Kitz	Hand-wheel nut changed to DR type. Up to 50mm

Cimberio DZR		Hydroflow	Up to 50mm
Maxiflo DZR		Maxiflo/Irrigation Epress	Up to 50mm
AppFlo DZR		Steel & Tube	Up to 50mm
Logi valve		Promains	Up to 50mm

## Ball valves for water and wastewater

Valves in this section are for use on processes and plant services.

### General requirements

- a) Ball valves may be used by application up to 50mm only.
- b) Steel ball valves shall be manufactured to BS EN 1983.
- c) Copper alloy ball valves shall be manufactured to BS EN 13547.
- d) Threaded end connection shall be to BS21.
- e) Valves shall be clockwise closing, full port, and 2-piece.
- f) Minimum pressure rating shall be PN16.
- g) Handle shall be either a stainless-steel lever or grey cast iron tee with polymeric coating. For wastewater applications, the handle shall be stainless steel.
- h) Seat ring and packing ring from PTFE.
- i) Valves to be used for water shall comply with AS/NZS 4020.
- j) For wastewater applications all wetted parts shall be 316 stainless steels. Water applications may either be 316 stainless steel or dezincification resistant (DR/DZR) brass.
- k) Ball valves for transmission applications (including pump stations, headworks and treatment facilities) shall be 3-piece stainless steel valves meeting the requirements listed above.

### Quality Control

- a) All products shall be marked in accordance with the conformity assessment body's requirements.
- b) Certification of compliance with AS/NZS 4020 when used for water applications.
- c) Product certification to BS EN 1983 or BS EN 13547 as applicable.

### Procurement schedule

Minimum standard required	Design specific requirements	Supplier submission
Application use description		
Applicable valve manufacturing standard		
DZR brass or better		
Minimum PN16 rated		
Size (mm diameter)		
Threaded end connections, BS21		
PTFE seat and packing ring		
Full-port flow, 2 piece		
Polymeric coated or 316 stainless steel handle		
AS/NZS 4020 compliant for water use		
Product and Test certificates		

**Accepted products**

Product model/name	Image	Manufacturer/supplier	Specific limitation
Art.245; Art. 222C; Art.602		Bugatti Valvosanitaria	Water use
SBV		Hydroflow	Wastewater & water use
BG 412		Hydroflow	Water use
MVBBD		Maxiflo	Water use
VM BVSS2		VM (Asmuss)	Wastewater & water use
286W 287W		MRC Global	Water use
SSLW SSW		Promains	Water use (15 to 50mm)

**13.2.11 Non-return valves >50mm for pressure applications**

**General requirements**

- a) Minimum pressure rating shall be PN16.

- b) Ductile iron body casting shall comply with [section 13.1.11](#) of this standard.
- c) Valves shall be manufactured to AS 4794.
- d) Valves shall be swing check type with rubberised (vulcanised) steel disc.
- e) Downstream tapped ports shall be provided.
- f) Design shall allow for vertical installation.
- g) Refer to [section 13.4](#) for flange requirements.
- h) Non-return valves for water supply shall comply with AS/NZS 4020 for products in contact with drinking water.
- i) Non-return valves that do not comply with AS/NZS 4020 shall be marked in the casting “NOT SUITABLE FOR WATER SUPPLY” or equivalent.

### **Quality Control**

- a) All products shall be marked in accordance with the conformity assessment body’s requirements.
- b) Product certification to AS 4794.
- c) Casting test certificates as per [section 13.1.11](#).
- d) Polymeric coatings shall have product certification (ISO Type 5) to AS/NZS 4158.
- e) Certification of compliance with AS/NZS 4020 for water products.

### **Procurement schedule**

Minimum standard required	Design specific requirements	Supplier submission
Application use description		
Minimum PN16 rated		
Nominal diameter		
Flow velocity – design consideration		
Installation orientation – design consideration		
Pressure surge mitigation – design consideration		
<b>Manufacturing standards:</b> AS 1831 as implemented by <a href="#">section 13.1.11</a> AS 4794 as implemented by <a href="#">section 13.2.12</a>		
<b>Flanges:</b> Refer to <a href="#">section 13.4</a>		
<b>Protective coating:</b>		

Minimum standard required	Design specific requirements	Supplier submission
AS/NZS 4158 or Altex specified		
AS/NZS 4020 compliant for water use		
Product and Test certificates		

**Accepted products**

Product model/name	Image	Manufacturer/supplier	Specific limitation
Swing Flex (and) Surgebuster		Val Matic	Up to 600mm (larger sizes shall be by design and consultation with supplier)
Series 41		AVK	Up to 300mm

**13.2.12 Check valves <50mm for water and wastewater**

**General requirements**

- a) This section excludes backflow prevention (refer [section 13.2.14](#)) or boundary kits for PWC systems (refer [section 13.2.15](#)).
- b) Valves used for water shall comply with AS/NZS 4020.
- c) Check valves shall be manufactured to AS1628 or BS5154.
- d) Threaded end connections shall be to BS21.
- e) Minimum pressure rating shall be PN16.
- f) For wastewater applications all wetted parts shall be 316 stainless steel. Water applications may either be 316 stainless steel or dezincification resistant (DR/DZR) brass.

**Quality Control**

- a) All products shall be marked in accordance with the conformity assessment body's requirements.
- b) Certification of compliance with AS/NZS 4020.
- c) Product certification to AS/NZS1628 or BS5154 as applicable.

**Procurement schedule**

Minimum standard required	Design specific requirements	Supplier submission
Application use description		

Minimum standard required	Design specific requirements	Supplier submission
Applicable valve manufacturing standard		
DZR brass or better 316 stainless steel for Wastewater		
Minimum PN16 rated		
Size (mm diameter)		
Threaded end connections, BS21		
PTFE seat and packing ring		
Full-port flow, 2 piece		
Polymeric coated or 316 stainless steel handle		
AS/NZS 4020 compliant for water use		
Product and Test certificates		

### Accepted products

Product model/name	Image	Manufacturer/supplier	Specific limitation
CP20 and CP 25		Petronelli valves	20mm and 25mm
Europa BVEC		Asmuss	Water only

## 13.2.13 Backflow preventers









### General requirements







- Boundary backflow prevention devices shall have a minimum working pressure rating of up to 1,200kPa and hydrostatic testing up to 1.25 x allowable operating pressure.
- Any component or lubricant in contact with the water supply shall comply with AS/NZS 4020.
- Valve body to be either ductile iron with polymeric coating to AS/NZS 4158, or 316 stainless steel, or cast bronze (unleaded), or DR brass, or approved polymer.
- Backflow preventers shall be manufactured to AS/NZS 2845.
- All internal parts shall be accessible to allow inline maintenance.
- Testable valve to be fitted with BSPT threaded test points.
- Threaded end connections shall be to BS21 and is limited up to 50mm valves.
- Flanged devices flanges shall comply with AS/NZS 4087.
- Flange facing shall be raised face B1.
- Valve design will allow for both horizontal and vertical installation.





### Quality Control

- a) All products shall be marked in accordance with the conformity assessment body's requirements.
- b) Product certification to (ISO Type 5) AS/NZS 2845.
- c) Polymeric coatings shall have product certification to AS/NZS 4158.
- d) Certification of compliance with AS/NZS 4020.

**Standardised products**

Product model/name	Image	Manufacturer/supplier	Specific limitation
007		Watts	Specific to application and legislative requirement
009			
2000SS			
4000SS			
757ISR			
957ISR			
LF7R			
007-SS (Double Check)			
009-SS (RPZ)			

Product model/name	Image	Manufacturer/supplier	Specific limitation
350 (and ST)		Wilkins	Specific to application and legislative requirement
375 (and ST)			
950			
975			
700			
AST			

Product model/name	Image	Manufacturer/supplier	Specific limitation
<p>4A-100</p> <p>4A-200</p> <p>4AE-100</p> <p>4AE-200</p>		<p>Aqualine (Apollo)</p>	<p>Specific to application and legislative requirement</p>
<p>Colt C400</p> <p>Colt C500</p>		<p>Ames</p>	<p>Specific to application and legislative requirement</p>
<p>LOGI DOV</p>		<p>LOGI</p>	<p>Specific to application and legislative requirement</p>
<p>DCV</p> <p>RPZ</p>		<p>Beeco</p>	<p>Specific to application and legislative requirement</p>

Product model/name	Image	Manufacturer/supplier	Specific limitation
			
CT20-Z		Acuflo	Specific to application and legislative requirement

### 13.2.14 Boundary kits for pressure wastewater collection (PWC) system

#### General requirements

- All components shall have a minimum pressure rating of PN16.
- The boundary kit shall consist of a ball valve isolation valve, non-return and flushing point. The kit shall have a maximum of six threaded joints between the components; including the end connections. All threaded jointing using hemp and graphite.
- All fittings shall be 316 stainless-steel. The flushing point (Tee) shall be fitted with a polymer threaded plug. Tail end or transition fittings shall be 316 stainless steel or a direct electrofusion transition to PE pipe.
- The ball valve shall comply with the requirements in [section 13.2.11](#) for wastewater. The valve shaft shall be fitted with a stainless-steel square top.
- The access box shall comply with the requirements in [section 13.8.2](#) for boxes for valves.

#### Quality Control

- All components shall be marked in accordance with the conformity assessment body's requirements.
- Individual components as specified by the referenced sections in the general requirements.
- Valve kits shall be pre-assembled and hydrostatically tested to 1600kPa with certification provided.

#### Accepted products

Product model/name	Image	Manufacturer/supplier	Specific limitation
E/one PWC BK with stubs		E/One - Ecoflow	-
RBCK 1403		Aquatec	Use suitably rated valve box class based on pit location
PSS-BK4		Mono	-
PWC boundary kit		Aquatec	-

Gillies		Hygrade	-
---------	---	---------	---

### 13.2.15 Knife gate valves 50mm diameter and greater

#### General requirements

- Ductile iron body casting shall comply with [section 13.1.11](#) of this standard.
- For treatment plants where the surrounding environment is harsh, the valve body shall be stainless steel 316L.
- Valves shall have a minimum pressure rating of PN10. **Note:** The design shall demonstrate that the valve selected is appropriate for the maximum upstream and downstream static pressure.
- Spindle shall be non-rising.
- Spindle seal shall be non-asbestos gland box or O-ring that is accessible for replacement under full operating pressure.
- Valve operating torque shall not exceed 125Nm at the fully unbalanced allowable operating pressure, otherwise a gearbox shall be equipped, see [section 13.2.4](#).
- The direction of rotation of input shaft shall be clockwise to close the valve for wastewater and anticlockwise for water.
- The valve handwheel operating direction shall be permanently marked on the valve, gearbox, spindle cap or hand-wheel.
- Valves shall allow for bi-directional flow and bi-directional sealing. Flow shall be full bore.
- Refer to [section 13.4](#) for flanges.
- Polymeric coatings shall comply with AS/NZS 4158.
- Acceptable manufacturing standards are AS 6401 and AWWA C520.

#### Quality Control

- Casting test certificates as per [section 13.1.11](#).
- Knife gate valves shall have product certification (ISO Type 5) to AS6401 or AWWA C520.
- Polymeric coatings shall have product certification (ISO Type 5) to AS/NZS 4158.
- Elastomeric joint seals shall have product certification (ISO Type 5) to AS 1646 and AS 681.1 (EN 681-1).
- All products shall be marked in accordance with the conformity assessment body's requirements.

#### Procurement schedule

Minimum standard required	Design specific requirements	Supplier submission
Application use description		
Nominal diameter		
<b>Manufacturing standards:</b> AS 1831 as implemented by <a href="#">section 13.1.11</a> , and AS6401 or AWWA C520 with specific requirements stated by <a href="#">section 13.2.16</a>		

Minimum standard required	Design specific requirements	Supplier submission
<b>Protective coating:</b> AS/NZS 4158 or Altex specified		
Elastomeric seals to AS1646		
<b>Flanges:</b> Refer to <a href="#">section 13.4</a>		
<b>Valve operability/input/output</b>		
Installation orientation		
<i>Minimum pressure rating:</i> PN10		
Maximum operating pressure of installation		
System test pressure		
Maximum flow velocity		
Upstream maximum static pressure		
Downstream maximum static pressure		
Valve closing direction		
Operation input (i.e. hand-wheel, actuator, etc.)		
Maximum handwheel diameter (if required – refer gearboxes for valves)		
Maximum operating torque for specified handwheel diameter is 356 N		
<b>Actuation:</b> <i>Gearboxes, required for input over 125 Nm unbalanced operation – attach procurement schedule from <a href="#">section 13.2.4</a></i> <i>Electric actuators – attach procurement schedule from <a href="#">section 13.13.5</a></i>		
<b>Valve specific information submittal</b>		
Valve manufacturer		
Country of valve manufacture		
Valve model		
Primary dimensions (or include drawings)		
Year of manufacture		
Serial number (supplied with each valve)		
Product and Test certificates		

**Accepted products**

Product model/name	Image	Manufacturer/supplier	Specific limitation
Keystone knife gate valve		Emerson	Wastewater plant facilities
Stafsjö WB14E		Ebro Armaturen	Treatment plants

**13.2.16 Globe valves (stopcock) 50mm diameter and smaller**

Valves in this section **shall not be used** for water mains isolation, but **only for lot water service connections**. For network isolation purposes using gate valves, refer to [section 13.2.1](#).

**General requirements**

- f) Valves shall be manufactured to BS 5433 or BS 5154.
- g) All brass components shall be dezincification resistant (DR/DZR).
- h) Minimum pressure rating of PN16 with threaded end connections.
- i) Valves shall be clockwise closing and fitted with a brass T-handle.
- j) The stem seal shall be replaceable under pressure and be either braided PTFE yarn or EPDM O-ring.
- k) The valve seal shall be replaceable, and the seat be of adequate thickness to allow re-cutting for maintenance.

**Quality Control**

- d) All products shall be marked in accordance with the conformity assessment body's requirements.
- e) Certification of compliance with AS/NZS 4020.
- f) Product certification to BS5433 or BS 5154.

**Procurement schedule**

Minimum standard required	Design specific requirements	Supplier submission
Application use description		

Minimum standard required	Design specific requirements	Supplier submission
Applicable valve manufacturing standard		
DZR brass or better		
Minimum PN16 rated		
Size (mm diameter)		
Threaded end connections, BS21		
PTFE or EPDM stem seal		
Polymeric coated handwheel or better		
AS/NZS 4020 compliant for water use		
Product and Test certificates		

**Accepted products**

Product model/name	Image	Manufacturer/supplier	Specific limitation
EBCO SV5402FCR to SV5408FCR		Ebco/WSP	
EBCO SV5402MCR		Ebco/WSP	
EBCO SV5420BCR to SV5463BCR		Ebco/WSP	

### 13.2.17 Penstocks

#### General requirements

- a) The general assembly shall be manufactured from stainless steel grade 316 as defined by ASTM A312M. General assembly includes but is not limited to:
  - Side frame, yoke, door and guides
  - Spindle, spindle couplings and spindle guides
  - Spindle pedestal
  - Spindle protection tube
  - Hand wheel
- b) All fasteners shall be grade 316 in accordance with ATSM A276.
- c) Spindle nuts shall be C95810 Aluminium bronze in accordance with AS 1565.
- d) Door guide wear strips and door seal shall be Ultra-High Molecular Weight Polyethylene (UHMWPE).
- e) Bottom seal shall be elastomeric joint seals and have product certification (ISO Type 5) to AS 1646 or AS 681.1 (EN 681-1).
- f) Any component or lubricant in contact with the water supply shall comply with AS/NZS 4020.
- g) Penstock seals must be fixed on gate for easy removal with the gate for maintenance.
- h) The leakage rate for penstocks shall not exceed 0.4 litres per minute, per meter length of the sealed perimeter length.
- i) Non-rising spindle shall be considered where headroom is limited.
- j) Hand wheels (where fitted) must be installed between 900 and 1200 mm above the standing surface.
- k) Grade 316L stainless steel must be used in lieu of grade 316 wherever thickness of components exceeds 6 mm.

#### Quality Control

- a) All products shall be marked in accordance with the conformity assessment body's requirements.
- b) For all stainless-steel welding required, the manufacturer shall provide the necessary welding qualification and procedures including quality assurance carried out during the manufacturing and assembly of penstocks.
- c) Certification of compliance with AS/NZS 4020 (if applicable).

#### Accepted products

Product model/name	Image	Manufacturer/supplier	Specific limitation
Inlet Penstock		Watergates NZ	By design

Fernco Penstock		Fernco	By design
-----------------	---	--------	-----------

## 13.3 Couplings and connections

### 13.3.1 Mechanical couplings, un-restrained, for water supply and sewer

This section **excludes** couplings for use on **polyethylene pipelines**. Refer [section 13.1.7](#). The purposes of un-restraint mechanical couplings shall be for leak repair, damaged pipe section replacement or designated dismantling locations only. Applications are where no movement restraint is required but **shall not be used for ordinary pipe jointing of new pipelines or as a deflection/articulation joint, refer [section 13.3.3](#)**.

#### General requirements

- Ductile iron body casting shall comply with [section 13.1.11](#) of this standard.
- Couplings shall comply with AS/NZS 4998.
- Minimum pressure rating is PN16.
- Joint seals shall be EPDM, NBR or NR as suitable for the specific application and complying with AS 1646 and AS 681.1 (EN 681-1).
- Fasteners shall be to section [13.5](#) and [13.6](#). Bolt selection material and coating must be suitable for the specific conditions.
- Refer to [section 13.4](#) for flanges.
- Any component or lubricant in contact with the water supply shall comply with AS/NZS 4020.

#### Quality Control

- All products shall be marked in accordance with the conformity assessment body's requirements.
- Couplings shall have product certification (ISO Type 5) to AS/NZS 4998.
- Casting test certificates as per [section 13.1.11](#).
- Polymeric coatings shall have product certification (ISO Type 5) to AS/NZS 4158.
- Certification of compliance with AS/NZS 4020 where used for water applications.

#### Procurement schedule

Minimum standard required	Design specific requirements	Supplier submission
Application use description		
Connecting pipe material type and rating		

Minimum standard required	Design specific requirements	Supplier submission
Application diameter/range		
Minimum PN16 rated		
Fasteners		
<b>Manufacturing standards:</b> AS 1831 as implemented by <a href="#">section 13.1.11</a> AS/NZS4998 as implemented by this section for unrestrained flange adaptors		
<b>Protective coating:</b> AS/NZS 4158 or Altex specified		
AS/NZS 4020 compliance (if for water)		
Product and Test certificates		

**Accepted products**

Listed products are for general acceptance up to 300mm diameter. Project specific suitability must be confirmed over this size.

Product model/name	Image	Manufacturer/supplier	Specific limitation
Maxifit – Couplers and Flange adaptors		Viking Johnson	Not for PE or articulation joint
Vari-Gib		Wang	Not for PE or articulation joint
Series 601;602;603		AVK	Not for PE or articulation joint

Product model/name	Image	Manufacturer/supplier	Specific limitation
Multi-gib		Deks	Not for PE or articulation joint
Unrestrained S/S barrel coupling		Daemco	Not for PE or articulation joint
VPC couplings		Clover pipe	
Unrestrained S/S barrel coupling		Derwent	100mm and 150mm
Hiwa universal coupling (FC 10-A) and flange adaptor (FA10-A)		Hiwa / Appletons	Not for PE or articulation joint  Flange adaptor is unrestrained

### 13.3.2 Mechanical couplings, restrained, for water supply and sewer

This section **excludes** couplings for use on **polyethylene pipelines**. Refer [section 13.1.7](#). These couplings are used for designated dismantling locations or damaged pipe section replacement but **shall not be used for ordinary pipe jointing or as a deflection/articulation joint, refer [section 13.3.3](#)**.

#### General requirements

- Ductile iron body casting shall comply with [section 13.1.11](#) of this standard.
- Couplings shall comply with EN12842 and EN14525 as appropriate.
- Minimum pressure rating shall be PN16.
- Fasteners shall be to section [13.5](#) and [13.6](#). Bolt selection material and coating must be suitable for the specific conditions
- Any component or lubricant in contact with the water supply shall comply with AS/NZS 4020.
- Joint seals shall be EPDM complying with AS 1646 and AS 681.1 (EN 681-1).
- Refer to [section 13.4](#) for flanges.

**Quality Control**

- a) All products shall be marked in accordance with the conformity assessment body's requirements.
- b) Couplings shall have product certification (ISO Type 5) to EN14525 or EN12842.
- c) Casting test certificates as per [section 13.1.11](#).
- d) Polymeric coatings shall have product certification (ISO Type 5) to AS/NZS 4158.
- e) Certification of compliance with AS/NZS 4020 where used for water applications.

**Procurement schedule**

Minimum standard required	Design specific requirements	Supplier submission
Application use description		
Connecting pipe material type and rating		
Application diameter/range		
Minimum PN16 rated		
Fasteners		
<b>Manufacturing standards:</b> AS 1831 as implemented by <a href="#">section 13.1.11</a> EN14525 as implemented by this section		
<b>Protective coating:</b> AS/NZS 4158 or Altex specified		
AS/NZS 4020 compliance (if for water)		
Product and Test certificates		

**Accepted products**

Product model/name	Image	Manufacturer/supplier	Specific limitation
Aquagrip; Aquafast; Ultragrip		Viking Johnson	Not for PE articulation joint

Product model/name	Image	Manufacturer/supplier	Specific limitation
Sytem 2000; Synoflex; Vario		Hawle	<p>Not for PE articulation joint</p> <p>System 2000 can be considered as an alternative to electrofusion welding where appropriate for new installations.</p>
Multi/Joint 3000		Georg Fischer	Not for PE articulation joint
VAG Dismantling joint		VAG Armaturen	Flanged dismantling joint. Not for PE or d articulation joint
Type 265		AVK	Flanged dismantling joint. Not for PE or articulation joint
PAS30; PAS20		Erhard	Flanged dismantling joint. Not for PE or articulation joint
AVK Vladux/Sureflow		AVK	Flanged dismantling joint.

Product model/name	Image	Manufacturer/supplier	Specific limitation
FD10; FD20		Hiwa / Appletons	Flanged dismantling joint. Not for PE or articulation joint

### 13.3.3 Mechanical couplings, flexible restrained joints for articulation and expansion

#### General requirements

- Ductile iron body casting shall comply with [section 13.1.11](#) of this standard.
- Polymeric coatings shall have product certification (ISO Type 5) to AS/NZS 4158.
- Steel bellows shall be manufactured to BS EN 14917 or ASTM F1120-87.
- Stainless steel fittings shall be grade 316.
- Fasteners shall be to [section 13.5](#) and [13.6](#). Bolt selection material and coating must be suitable for the specific conditions
- Minimum pressure rating shall be PN16 for pressure pipe.
- Minimum crush load rating for gravity application shall be SN16 unless otherwise specified.
- Refer to [section 13.4](#) for flanges.
- Any component or lubricant in contact with the water supply shall comply with AS/NZS 4020.

#### Quality Control

- All products shall be marked in accordance with the conformity assessment body's requirements.
- Casting test certificates as per [section 13.1.11](#).
- Steel bellows shall have product certification to (ISO Type 5) ASTM F1120-87.
- Polymeric coatings shall have product certification (ISO Type 5) to AS/NZS 4158.
- Certification of compliance with AS/NZS 4020 where used for water applications.

#### Procurement schedule

Minimum standard required	Design specific requirements	Supplier submission
Application use description / drawing		
Installation environment: external, marine, etc.		
Fluid type. <i>Note:</i> wastewater requires a smooth bore to prevent material snagging and causing obstruction.		
Nominal diameter		
Minimum operating pressure PN16		
Test pressure minimum 1.25 x PN16		

Minimum standard required	Design specific requirements	Supplier submission
Maximum flow rate		
<b>Manufacturing standard:</b> BS EN 14917 ASTM F1120-87 As implemented by this section		
Joint seals to AS 1646		
Fasteners		
AS/NZS 4020 compliance (if for water)		
<b>Protective coating:</b> AS/NZS 4158 or Altex specified		
<b>Type of movement (may be combination of):</b> Lateral thrust or expansion Horizontal/Vertical Angular Bi-planar Hinged Double-hinged Universal (restrained) Double end		
<b>Flanges:</b> Refer to <a href="#">section 13.4</a>		
Overall length		
Design temperature range: minimum to maximum °C		
Axial shortening mm		
Axial extension mm		
Design horizontal offset		
Design vertical offset		
Design angular deflection		
Axial force (kN)		
Lateral force (kN) compression and contraction		
<b>Fatigue (cycles):</b> 5% of design movements (maintenance) 25% of design movements (events, seismic, subsidence)		

Minimum standard required	Design specific requirements	Supplier submission
80% of design movements (daily temperature and pressure variations, vibration)		
Product and Test certificates		

**Accepted products**

Product model/name	Image	Manufacturer/supplier	Specific limitation
Flex-Tend		Hynds	Design input required
FJ restraint		Romac	Design input required
EJ400		Romac	Design input required
Jolly joint		Nova Siria	Design input required
SEB		AFLEX	Design input required
UEB			
TEB			
			



### 13.3.4 Repair and off-take repair clamps for water supply

This section **excludes** clamps for use on **polyethylene pipelines**. Refer [section 13.1.7](#)

#### General requirements

- a) Minimum pressure rating shall be PN16.
- b) Ductile iron body casting shall comply with [section 13.1.11](#) of this standard.
- c) Stainless steel fittings shall be grade 316.
- d) Fasteners shall be to section [13.5](#) and [13.6](#). Bolt selection material and coating must be suitable for the specific conditions.
- e) Clamps shall comply with AS 4181 and be specified Type R for rigid pipe or type F for flexible pipe applications.
- f) Any component or lubricant in contact with the water supply shall comply with AS/NZS 4020.

#### Quality Control

- a) All products shall be marked in accordance with the conformity assessment body's requirements.
- b) Couplings shall have product certification (ISO Type 5) to AS 4181.
- c) Casting test certificates as per [section 13.1.11](#).
- d) Polymeric coatings shall have product certification (ISO Type 5) to AS/NZS 4158.
- e) Certification of compliance with AS/NZS 4020.

#### Procurement schedule

Minimum standard required	Design specific requirements	Supplier submission
Application use description		
Connecting pipe material type and rating		
Application diameter/range		
Minimum PN16 rated		
Fasteners		
<b>Manufacturing standards:</b> AS4181 as implemented by this section		
<b>Protective coating:</b> AS/NZS 4158 or Altex specified		
AS/NZS 4020 compliance (if for water)		
Product and Test certificates		

**Accepted products**

Product model/name	Image	Manufacturer/supplier	Specific limitation
Open-Flex1; Straub-flex; Straub clamp SCE		Straub	Un-restrained. 50mm to 250mm only
Straub –metal-grip; Straub-eco-grip		Straub	Self-restrained. 50mm to 250mm only
K2		Kawandah	Un-restrained. 50mm to 250mm only
Stainless steel repair and tapped off-take clamps		Derwent	Un-restrained. 80mm to 250mm only
Repair; Tapped Offtake Repair		Wang	Un-restrained. 50mm to 250mm only
CR,CTR; CF; CFW		Rapid	Un-restrained. 50mm to 250mm only
EasiClamp, EasiTap		Viking Johnson	80mm to 150mm only

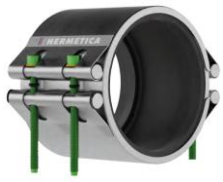
Product model/name	Image	Manufacturer/supplier	Specific limitation
Norma connect		Norma / P&I	Un-restrained. 50mm to 250mm. Excludes min-clamp
Hermetica		Promains	Self-restrained and un-restrained

### 13.3.5 Couplings (banded) for sewer gravity applications

#### General requirements

- Shear ring and band fasteners shall be stainless steel grade 316.
- Couplings shall be manufactured to AS/NZS 4327 with coupling elastomer type B.

#### Quality Control

- All products shall be marked in accordance with the conformity assessment body's requirements.
- Couplings shall have product certification (ISO Type 5) to AS/NZS 4327.

#### Procurement schedule

Minimum standard required	Design specific requirements	Supplier submission
Application use description		
Connecting pipe material type and rating		
Application diameter/range		
316 stainless steel shear ring and band fasteners		
Minimum SN16 rated		
<b>Manufacturing standards:</b> AS/NZS 4327, Type B as implemented by this section		
Product and Test certificates		

#### Accepted products

Product model/name	Image	Manufacturer/supplier	Specific limitation
Type B		Fernco	Gravity sewer only
Type B		Aqualine	Gravity sewer only
Awaduct Flex connect		Rehau	Gravity sewer only
Type B		Clarkes pipes	Gravity sewer only
VIPSeal Type B		Pipe and Infrastructure	Gravity sewer only
Deks Type B		DLM Wallace	Gravity sewer only

### 13.3.6

### 13.3.7 Tapping bands for water connections

This section **excludes** tapping for use on **polyethylene pipelines**. Refer [section 13.1.7](#)

#### General requirements

- Tapping bands shall comply with AS/NZS 4793 as the normative.
- Tapping bands for use on PVC shall dimensionally comply with AS/NZS 1477.
- Minimum pressure rating shall be PN16.
- Fasteners shall be 316 stainless-steel, refer to section [13.5](#) and [13.6](#).
- Gunmetal tapping bands shall be LG2 only.
- Minimum nominal tapping ID of 20mm.
- Tapping bands may be used on pipe up to a maximum diameter of 300NB. A Tee-connection shall be installed for pipes of larger diameter.
- Any component or lubricant in contact with the water supply shall comply with AS/NZS 4020.

#### Quality Control



- All products shall be marked in accordance with the conformity assessment body's requirements.
- Tapping bands shall have product certification (ISO Type 5) to AS/NZS 4793.
- Certification of compliance with AS/NZS 4020.

#### Procurement schedule

Minimum standard required	Design specific requirements	Supplier submission
Application use description		
Connecting pipe material type and rating		
Tapping diameter		
Pipe diameter/range (maximum pipe diameter use 300 NB)		
Minimum PN16 rated		
<b>Manufacturing standards:</b> AS/NZS4793 PVC couplings to AS/NZS1477 As implemented		
Product and Test certificates		

#### Accepted products

Product model/name	Image	Manufacturer/supplier	Specific limitation
AC/DI Tapping strap (Model with Stainless steel bolts)		Giltech Precision	Application specific for PVC, DI and AC pipe

Product model/name	Image	Manufacturer/supplier	Specific limitation
Plassaddle for S2 PVC		Plasson	100 -150mm PVC series 2 Only – refer to section 13.1.7 for PE option (includes tapping ferrule)
4N for PVC and DI		Stockbrands	PVC series 1 and 2; DI pipe, AC pipe – refer to <a href="#">section 13.1.7</a> for PE option (includes tapping ferrule)
Promains LG2		Promains	Application specific for PVC, DI and AC pipe
P&I LG2		Pipe and Infrastructure	Application specific for PVC, DI and AC pipe
Hygrade LG2		Hygrade	Application specific for PVC, DI and AC pipe
Ebco (BSP and compression) tapping ferrule		WSP	
Self-tapping ferrule		Promains	
CB25PE Self-tapping ferrule		Strongcast	



### 13.3.8 Roll-groove couplings and fittings for water supply and wastewater

The purposes of the restraint mechanical system shall be for new installation and repair where it is agreed with Watercare's operations team that the system is fit for purpose. This system is specific to roll groove jointing and shall not be used on **non-grooved (ordinary pipe)**. The appropriate couplings and fittings shall be selected based on the operational environment and pipe material.

#### General requirements and quality control

- a) Minimum pressure rating is PN16.
- b) Castings: **Stainless steel**: ASTM A351, ASTM A743 or ASTM A744 – Grade CF8M or CF8, ASTM A890 – Grade 2A CE8MN or Grade 5A CE3MN
- c) Fabrications: **Stainless steel**: ASTM A312 – Grade TP316L, WP316L or CR316L, ASTM A240 – S31600, or S31603, ASTM A276 – S31600
- d) Gaskets: ASTM D2000
- e) Fasteners: **Stainless steel**: ASTM A193 – Class 2, Grade B8M and ASTM A194 – Grade 8M, Heavy Hex, ASTM F738M – Class A4-80 and ASTM F836M – Class A4-80, ASTM F593 – Group 2, Condition CW, Alloy 316 and ASTM F594 – Group 2, Condition CW, Alloy 316, ISO 3506 – Grade A4-80 or A4-70
- f) Rings: ASME SA105 / ASTM A105 or ASME SA105N / ASTM A105N and/or ASME SA350 LF2 Class 1 / ASTM A350 LF2 Class 1 or ASME SA350 LF2 Class 1 / ASTM A350 LF2 Class 1
- g) Any component or lubricant in contact with the water supply shall comply with AS/NZS 4020.

Product model/name	Image	Manufacturer/supplier	Specific limitation
Stainless steel flexible coupling (77S and W77S)		Victaulic	Design input and approval from operations required for use. For use on stainless steel pipe only in accordance with manufacturers recommendation.  DN20 – DN 450
Rigid coupling (489 and W489)		Victaulic	Design input and approval from operations required for use. For use on stainless steel pipe only in accordance with manufacturers recommendation.  DN40 – DN300

Product model/name	Image	Manufacturer/supplier	Specific limitation
Grooved fittings		Victaulic	Design input required
Butterfly valve (Series 461)		Victaulic	Design input required

## 13.4 Flanges

This section relates to waterworks flanges for linear system

### General requirements

- a) Flanges shall be metal as specified and manufactured to AS/NZS 4087 (standard covers sizes up to 1200mm).
- b) Weld neck flanges to AS/NZS 4087 (neck manufactured to AS 2129) may be specified where the design requires high fatigue or stress resistance as typically required for Transmission installations.
- c) For special installations where the component is larger than 1200mm or cannot be supplied to AS/NZS 4087, then BS EN 1092-1 (-2 for Ductile iron flanges), type 11 is used.
- d) Flange face finish shall be typically machine faced:
  - i. Serrated concentric or serrated spiral grooves for use with fibre or fibre-blend gaskets:

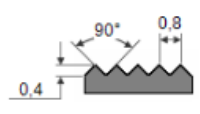
Serration depth	Serration width	
0.4mm	0.8mm	

- ii. Or, stock finish for use with rubber gaskets

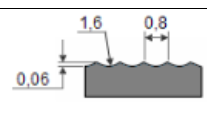
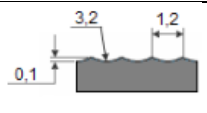
Flange size	Radius of round nosed tool mm	Groove depth	Feed rate	
Up to 350mm	min. 1.0mm, max. 1.6mm	0.06mm	0.8mm per revolution	
Over 350mm	min. 1.6mm, max 3.2mm	0.1mm	1.2mm per revolution	

- iii. Or, smooth finish for use with rubber gaskets at low pressure and with steel gaskets

Radius of round nosed tool mm	R <sub>a</sub> (EN ISO 4287) μM		R <sub>z</sub> (EN ISO 4287) μM	
	Min.	Max.	Min.	Max.
min. 1.0mm	3.2	12.5	12.5	50

- e) Flange facing does not apply to backing rings on bellows, or for use with PE flange spigots
- f) Flange materials shall have a minimum yield stress of no less than 250 MPa.
- g) Stainless steel grade shall be 316L grade.
- h) Ductile iron flanges shall be minimum 450-10 grade (unless part of accepted cast fitting at lower grade), refer [section 13.1.11](#).
- i) Grey cast iron or copper alloy flanges are not accepted for pipework.
- j) Flanges shall be raised face (steel Figure B7 or ductile iron Figure B5) and minimum PN16 rated.

- k) Flat face flanges may only be used on flat pump facings or specific design where a raised face may cause the connecting flange to break e.g. Cast iron or GRP.
- l) Weld-neck flanges shall be required as specified.
- m) Uncoated flanges shall be coated with a heavy duty anti-corrosive product suitable for storage purposes. The corrosion protection product used shall be easily removable for installation. All ductile iron flanges shall be fully factory coated to AS/NZS 4158 with the raised-face area uncoated when specified.
- n) Spot facing may be required on the back face of cast flanges if the rake angle exceeds 1%. Refer to Watercare's General Mechanical Construction standard (ESF-600-STD-701).

**Quality Control**

- a) All products shall be marked in accordance with the conformity assessment body's requirements.
- b) Flanges shall have product certification (ISO Type 5) to AS/NZS 4087 or BS EN1092.
- c) Material testing of ductile iron flanges shall be certified as per [section 13.1.11](#).
- d) Material testing of stainless steel flanges shall be certified to ASTM A240.
- e) Material testing of mild steel flanges shall be certified to AS 2074.

**Procurement schedule**

Minimum standard required	Design specific requirements	Supplier submission
Application use description		
Fluid type		
Connecting pipe material type and rating		
Flange material		
Pipe outside diameter		
Pipe internal diameter (without lining)		
Flange nominal diameter		
<b>Flange standard</b> AS/NZS 4087, or BS EN 1092-1/2 by specific design		
Raised face Figure B5 or B7		
Flanges face coated/ uncoated		
Weld-neck required y/n (to be specified)		
Minimum operating pressure PN16		
Minimum test pressure (to be specified)		
Product and Test certificates		

## 13.5 Bolts and nuts

Refer to the General Mechanical Construction standard for specific bolt and nut applications. Others may be specified based on specific design.

### General requirements

- a) Bolts for general purpose and small flange connections shall be ISO metric manufactured to AS 1111.1 grade 4.6 or 316 stainless steel class 50.
- b) Nuts for general purpose and small flange connections shall be ISO metric manufactured to AS 1112.3 grade 4.6 or 316 stainless steel class 50.
- c) Bolts and nuts for high strength structural engineering or large flanges shall be manufactured to AS/NZS 1252.1 grade 8.8 or 316 stainless steel class 80. Alternative to this standard AS1110.1 (ISO4014) compliant with ISO898-1 can be used.
- d) Hot dip galvanising on fasteners shall be completed to AS 1214 with the following oversize tapping allowance:

Size	Microns
M22	400
M24	450
M27	500
M30	550
M33	600
M36	600
M36 to M48	800
M48 to M64	1000

### Quality Control

As applicable to the application:

- a) Bolts shall have product certification (ISO Type 5) to AS 1111.1.
- b) Nuts shall have product certification (ISO Type 5) to AS 1112.3.
- c) Structural bolts shall have product certification (ISO Type 5) to AS/NZS 1252.1.
- d) Hot dipped galvanised bolts and nuts shall be certified to AS 1214.

## 13.6 Washers

### General requirements

- a) Washers shall be manufactured from mild steel to AS/NZS 3679.1 or 316 stainless steel.
- b) Hot dip galvanising shall be completed to AS/NZS 4680.
- c) Refer to [section 13.11.6](#) for isolation washers used for cathodic protection.

### Quality Control

- a) Mild steel washers shall have product certification to AS/NZS 3679.1.

## 13.7 Gaskets for flanges

### General requirements

- a) Flange gaskets shall be manufactured to comply with WSA 109 or BS 7531, BS EN 12560-2 and BS EN 1514-1, and be applicable to the gasket type.
- b) Elastomeric gaskets (EPDM and NBR) shall be manufactured to comply with AS 1646 or AS 681.1.
- c) Gasket dimensions shall be as required by the relevant flange product standard e.g. AS 4087 or EN 1092 (Which references EN 1514 for gasket types)
- d) Gaskets shall not contain any asbestos fibre.
- e) Any component or lubricant in contact with the water supply shall comply with AS/NZS 4020.
- f) EPDM gaskets used for water supply shall be UV stabilised, blue of colour and comprise of solid material without fabric reinforcement or other composite materials.
- g) Nitrile insertion rubber gaskets used for wastewater applications shall have hardness in the range between 60 and 75 IRHD units and shall have a cotton reinforcing fabric layer.
- h) Gasket materials shall generally be suitable for 1600kPa pipeline operating pressure and minimum 2000kPa test pressure unless a lower pressure is specified for gravity wastewater.
- i) The gasket inside diameter may be varied to accurately match the flange inside diameter.
- j) Gaskets shall be dimensioned such that the inside diameter does not protrude into the bore of the pipe.
- k) Gaskets for insulating flange joints shall be cut with an inside diameter 2mm less than the flange's internal diameter and an outside diameter 2mm larger than the flange's external diameter.

### Quality Control

- a) All products shall be marked in accordance with the conformity assessment body's requirements.
- b) Gaskets shall be tested to WSA 109 or BS EN 14772.
- c) Certification of compliance with AS/NZS 4020 for products in contact with water.

### Procurement schedule

Minimum standard required	Design specific requirements	Supplier submission
Application use description		
Connecting pipe material type and rating		
Nominal diameter		

Minimum standard required	Design specific requirements	Supplier submission
Fluid type		
Temperature range: minimum to maximum °C		
<b>Flange standard</b> Refer to <a href="#">section 13.4</a>		
Flange clamping force (tensile load (kN))		
Insulation flange purpose: ID 2mm smaller than flange and OD 2mm larger than flange		
Minimum operating pressure 1600kPa		
Minimum test pressure 2000kPa		
Product and Test certificates		

**Accepted products**

Product model/name	Manufacturer/supplier	Specific limitation
Klingersil C-4430	Klinger/ Seal Innovations	General joints as per mechanical construction standard
Inca	James Walker	General joints as per mechanical construction standard
Style 2500	Garlock	General joints as per mechanical construction standard
Flexitallic SF 2400 and SF 2800	Industrial Gasket Solutions Ltd.	Wastewater networks up to 300mm only
EPDM	N&P Industries – James Walker	Water networks up to 250mm, magnetic meter joints. Per design, see mechanical construction standard
Nitrile rubber gasket (NBR)		Wastewater flange joints
EPDM	SHUK	Networks water flange joint
Nitrile rubber gasket (NBR)		Wastewater flange joints
EPDM	Daemco	Networks water flange joints
EPDM	Allied Fastenings	Networks water flange joints
EPDM	Industrial Gasket Solutions Ltd.	Networks water flange joints

## 13.8 Manholes and street-ware

### 13.8.1 Covers for manholes and chambers

Applicable to covers for man access to chambers, maintenance access holes and inspection openings.



#### General requirements





- a) Covers and frames shall conform to EN 124 or AS3996 with the following application:
  - **EN 124** - The minimum class for any cover and frame shall be Class D 400 (Carriageways of major road speed limit > 100km/h). For areas with high wheel loads Class E 600 shall apply. Where there is any doubt, the stronger class shall be specified.
  - **AS3996** - The minimum class for any cover and frame shall be Class D (Carriageways imposing high nominal wheel loads). For areas with high wheel loads Class E or Class F shall apply. Where there is any doubt the stronger class shall be specified.
- b) The frame depth of covers shall be at least 100mm.
- c) Covers and frames of ductile iron shall have a bituminous coating in accordance with AS3996 or AS/NZS 3750.4 or EN 124.
- d) All fabricated steel covers and frames (not cast) shall be hot-dip galvanised after fabrication in accordance with AS/NZS 4680.
- e) Man access hole cover sets shall have a minimum clear opening of 600mm diameter.
- f) The cover surface slip resistance shall comply with AS/NZS 4586, class P5.



#### Quality Control

- a) All products shall be marked in accordance with the conformity assessment body's requirements.
- b) Manhole access covers shall have ISO Type 5 product certification to EN 124 or AS3996.
- c) For galvanised covers certification to AS/NZS 4680.
- d) All covers shall be certified AS/NZS 4586 for slip resistance.

#### Accepted products

Product model/name	Image	Manufacturer/supplier	Specific limitation
Maestro D400 600mm		EJ / Hygrade Water	Air sealed application
Maximo D400 800mm		EJ / Hygrade Water	Air sealed application

Product model/name	Image	Manufacturer/supplier	Specific limitation
Hinged Class D (Item 78255)		Humes	Vented and sealed application
Korum D400		Saint Gobain	Vented application
Pamtight D400; Pamrex D400		Saint Gobain	Air sealed application
Twino D400		EJ / Hygrade Water	Vented application
Water reservoir hatches		Peltech Engineering	Watercare standard design for reservoir hatches
Watercare chamber lids		Peltech Engineering	Watercare standard design for chamber access such as PRV chambers and air valve chambers

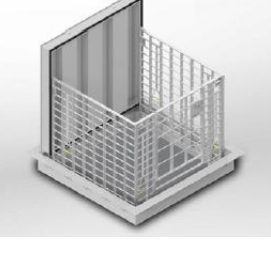
Product model/name	Image	Manufacturer/supplier	Specific limitation
Jamie		Clarks pipes	Vented application. (can be locked down with a bolt)
SMC Class E lockable, sealed polymer lid		SMC Materials Ltd	Locakable and vented applications
FSP series lids		Austral/Pump and Valve	Class A applications – requires bollard or raised installation to prevent damage by vehicle. Specific for sewer pump stations and valve enclosures. To be fitted with Watercare crox-key
Access Covers		McBerns	Class A applications – requires bollard or raised installation to prevent damage by vehicle. Specific for sewer pump stations and valve enclosures. To be fitted with Watercare crox-key

### 13.8.2 Surface boxes for housing meters and valves

Applicable to housing meter boxes and for gaining access to isolation valves and valve spindles

#### **General requirements**

- a) Box sizes shall allow adequate free space to maintenance and insert any tools required to complete operations intended to be contained within the box enclosure.
- b) Boxes installed in pedestrian only areas shall comply with AS3996 minimum Class A, where installed in driveways or footpaths (and possible light vehicle access) shall comply with AS3996

Class B rating and for heavy load driveways such as industrial areas and carriageways shall comply with AS3996 Class D rating.



- c) Box lid surface slip resistance shall comply with AS/NZS 4586, minimum class P5.
- d) Box lids shall be clearly marked in the casting in accordance with the intended content for 'METER', 'VALVE', 'SEWER' etc. as appropriate.
- e) Box lids shall be clearly marked in the casting to indicate the weight of the lid. This shall assist with determining whether a one- or two-man lift is required during inspection.
- f) Non-metallic boxes shall be fitted with a steel bar to allow locators to be used to trace buried or overgrown lids.
- g) Boxes shall be designed to prevent hydraulic uplift in high groundwater situations.
- h) Meter boxes shall be supplied with a removable base and support for pipework.
- i) Meter boxes shall be accompanied by a signal strength test to demonstrate that the material does not interfere with smart meter communications.
- j) Colour requirements of box lids are listed below:







Application	Colour of lid
Fire hydrants	Yellow
Valves in water network areas (Isolation, air release, scour)	White
Valves in water transmission areas (Isolation, scour)	Blue
Special controlled zone – Normally shut	Red
Wastewater valves and boundary kits	Red
Water meter boxes	Black
Grey water – all	Purple

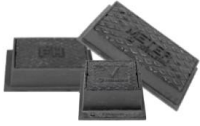

### Quality Control

- a) All products shall be marked in accordance with the conformity assessment body's requirements.
- b) Boxes shall have ISO Type 5 product certification to AS3996.
- c) Box lids shall have ISO Type 5 product certification to AS/NZS 4586.
- d) Signal strength test

### Accepted products

Product model/name	Image	Manufacturer/supplier	Specific limitation
Metallic Surface Boxes (made in India)		Humes	Heavy duty lids only. Check rating and location of use with supplier
Metallic Surface Boxes (made in India)		Hygrade/Hynds	Heavy duty lids only. Check rating and location of use with supplier

Product model/name	Image	Manufacturer/supplier	Specific limitation
Metallic Surface Boxes		Skellerns	Heavy duty lids. Check rating and location of use with supplier
DRA30/1 or /5		Draper Enterprises	Meter box and base, lid selection per location. Pedestrian rated only
AMBJ		Acuflo	Meter box and base, lid selection per location. Pedestrian rated only
Channell pits class C and D		Promains	Multiple meters. Bulk meters. Various sizes as required. Must be fitted with coloured puck to indicate water or sewer service. Fitted with lifting bolt. Pipework supported as per Watercare drawing
Warrior HB54 & HB36 series		Saint Gobain PAM	-
Sheet moulded composite chamber Class C150		Hynds	Multiple meters. Bulk meters. Various sizes as required. Must be fitted with coloured puck to indicate water or sewer service. Fitted with lifting bolt. Pipework supported as per Watercare drawing

Product model/name	Image	Manufacturer/supplier	Specific limitation
AMBT& AMBJT		Acuflo	Class B, Light traffic, footpaths
AMBG-600-UW		Acuflo	Class C, Light traffic, driveways and footpaths
AMBG-900-UW		Acuflo	Class B, Light traffic, driveways and footpaths

### 13.8.3 Manhole safety grilles

Manhole safety grilles for the purpose of fitting into manhole access lid frames where there are:

- Water system unsecured service chamber entries and scour chambers; and
- Sewerage maintenance holes/chambers and man access holes (manholes).

#### General requirements

- Manhole safety grilles shall comply with AS3996 Class A.
- Grilles shall be constructed from stainless steel 316L grade or an approved equivalent material with adequate strength and corrosion properties.
- The maximum opening size of any section of the grille fit and surface shall not pass more than 150mm diameter.

#### Quality Control

- All products shall be marked in accordance with the conformity assessment body's requirements.
- Manhole safety grilles product certification (ISO Type 5) to AS3996 Class A. This certification shall include the fit to the access lid frame design meeting the specified load requirements.

#### Accepted products

Product model/name	Manufacturer/supplier	Specific limitation
Impact – Korum-Twino	Impact Engineering	Fits Korum and Twino
Impact Maestro	Impact Engineering	Fits Maestro

Product model/name	Manufacturer/supplier	Specific limitation
MSG610S/S	T & T Bennett/Hygrade	Fits Maestro Fits to Humes lids
Hygrade HD	Impact Engineering	Fits hygrade HD 485mm ( <i>not for new lids, retrofit only</i> )
Hygrade LD	Impact Engineering	Fits hygrade LD 510mm ( <i>not for new lids, retrofit only</i> )
CSG600SSH	Calibre	Fits to Humes lids
CSG600SSM	Caliber	Fits Maestro lids
CSG600SSTK	Caliber	Fits Twino and Korum lids
CSG600SSC	Caliber	Fits Surecast hinged lids
CSG600SSRondo	Caliber	Fits Rondo 2D400 lids
SMC polymer safety grille	SMCMaterials Ltd	Fits SMC polymer lid
SSKORUMGRILL	Solo Plastics	Fits Korum

### 13.8.4 Prefabricated manholes in Concrete, PP, PE, or GRP

Applies to prefabricated man access chambers constructed from concrete or plastics for use in gravity sewers of ≤300mm NB connecting pipework

#### General requirements

- a) Elastomeric joints shall be EPDM, SBR, NR or CR complying with AS 1646 and AS 681.1 (EN 681-1). Joints shall be fully watertight to the installation depth
- b) Products shall be manufactured to:
  - Polypropylene to AS/NZS 5065
  - Polyethylene to AS/NZS 5065
  - Glass reinforced thermoplastic to ASTM D3262-11. Tanks and manholes shall be manufactured by filament wound or centrifugal casting process AS 3571.
  - Concrete to AS 4198
- c) The design shall prevent buoyancy to full chamber height.
- d) The nominal access throat diameter shall be minimum DN 600 with a maximum depth of 450mm.
- e) The depth of the lowest side of the throat to the first step rung shall be maximum 500mm.
- f) Load rating on the lid shall be HN-HO-72 in accordance with the NZTA Bridge Manual under installed conditions.
- g) The installed manhole shall be able to withstand lateral forces through soil loading, anticipated ground movements and top loading to the designed depth.
- h) For concrete manholes:

Exposure Classification / Manhole application	Durability requirements	Background notes
Larger Network manholes (Manholes with diameter greater than 1200mm) and All Transmission manholes	25mm internal Sacrificial thickness <sup>1</sup> OR Cast in Liner (PE or PVC) OR Special concrete mix <sup>2</sup>	Blend of appropriate durability considerations
Highly Aggressive <sup>3</sup> environment / installation / application	Cast in Liner (PE or PVC)	In-line with Highly Aggressive classification in AS 4198:2022
Manholes likely to be exposed to mildly aggressive or aggressive Tradewaste should be specified to provide Acid Resistance	SCM's, Sacrificial Liner, Cast in Liner or other specific Acid Resistant concrete mixes to suit environment	Mineral acid resistance not provided by Biocides

#### Notes:

<sup>1</sup> This is a layer of concrete on the inside of the manhole that is exposed to the interior environment that is intended to be lost during the service life. At the end of the service life the performance requirements of the product shall still be met.

<sup>2</sup> A special concrete mix (SCM) shall provide protection specifically against Biogenic corrosion and should be approved by Watercare. Cementitious materials will provide protection against mineral acids; not biogenic corrosion found in sewers.

<sup>3</sup> Manholes that receive high inflow volumes from sewers with pumped or turbulent inflows or are considered to have high levels of potentially corrosive sulphide/gas/other precursors of corrosion.

- i) For ladders and step rungs refer to [section 13.8.5](#).
- j) For manhole pipe invert connectors refer to [section 13.8.6](#).

#### Quality Control

- a) All products shall be marked in accordance with the conformity assessment body's requirements.
- b) Manholes shall have ISO Type 5 product certification to the applicable standard for the product material.
- c) Load rating certification compliant with HN-HO-72.
- d) Sample leak test to be carried out following manufacture of manhole risers. This shall be carried out in accordance with Watercare's General Civil Construction standard for a height up to 4.8m.

#### Procurement schedule

Minimum standard required	Design specific requirements	Supplier submission
Application use description		
Connecting pipe material type and rating		
<b>Nominal diameter</b> Min 1000mm for manholes		

Minimum standard required	Design specific requirements	Supplier submission
Min 675mm for terminating manholes		
Manhole riser depth		
<b>Joint seal:</b> Type Sealing (mH <sub>2</sub> O) > manhole riser depth		
Detail expected ground movement that the structure must be able to withstand		
Configuration – inlets and outlet detail / drawing		
Fall / grade through base per design code		
Energy dissipation		
Anti-floatation		
Manufacturing standard – applicable to parent material type		
Cover detail / drawing		
HN-HO-72 load rated when installed		
Ladder AS/NZS 1657		
Special treatment, coating or lining		
Concrete min 25mm additional cover over reinforcement (concrete chambers), or CaC, specific lining approval		
Product and Test certificates		

**Accepted products**

Product model/name	Image	Manufacturer/supplier	Specific limitation
Romold manhole system (DN1000 and DN625)		Australasia moulding	Specify to meet design

Product model/name	Image	Manufacturer/supplier	Specific limitation
Manhole/chambers		Maskell	Specific design
Concrete manholes: Manhole system (excl. Hyseal connectors)		Hynds	Specify to meet design
Pinnacle Manhole		Hynds	Specify to meet design
Perfect Manhole		Hynds	Specify to meet design with manufacturer
Concrete manholes: VT, Humes seal		Humes	Specify to meet design
KBL manhole plug		KBL / Hynds	Plug to seal unused manhole penetrations
ElePipe manholes		McDonald Concrete Group	Specify to meet design

Product model/name	Image	Manufacturer/supplier	Specific limitation
PKS PE manholes		Hynds PKS	Specific design with manufacturer

### 13.8.5 Ladders and step rungs for chambers

#### General requirements

- a) Step rungs and ladders shall be manufactured to comply with AS/NZS 1657.
- b) Hot dip galvanising on fasteners shall be completed to AS 1214.
- c) Step rungs can be used where chambers are less than 1500mm in diameter/square and less than 3m deep.
  - Step rungs shall be galvanised mild steel or an approved polymer. Encapsulated rungs must have a galvanised steel or stainless steel core with sufficient cover to prevent damage causing corrosion to the core.
- d) Ladders shall be used where chambers are more than 1500mm diameter/square or more than 3m deep.
  - Ladders shall be galvanised mild steel or aluminium to Watercare standard design and manufacturing requirements. Other materials are not permitted.
- e) Ladders or step rungs in contact with potable water shall comply with AS/NZS 4020.

#### Quality Control

- a) Step rungs shall have ISO Type 5 product certification to AS/NZS 1657.
- b) Hot dip galvanising to AS 1214.
- c) Compliance with AS/NZS 4020 for products in contact with water.

#### Accepted products

Product model/name	Image	Manufacturer/supplier	Specific limitation
KBL polymer step rung		KBL Ltd.	Manholes less than 3m deep and <1500mm diameter. Testing in accordance with EN13101 accepted.

Product model/name	Image	Manufacturer/supplier	Specific limitation
Pinnacle manhole step		Hynds	Manholes less than 3m deep and <1500mm diameter. Testing in accordance with EN13101 accepted.
Humes Galvanised step rung		Humes	Manholes less than 3m deep and <1500mm diameter.

### 13.8.6 Manhole invert connectors

#### General requirements



- Pipe material or fittings used in manufacturing the invert connector shall comply with the applicable standard listed under [section 13.1](#).
- Transmission wastewater invert connectors shall be typical concrete pipe or Watercare's standard cast in concrete collar detail for PE pipe.
- Heat shrunk transition pieces shall be factory applied.
- Glued fittings are not accepted.

#### Quality Control

- Pipe material shall be ISO Type 5 tested to the relevant pipe standard under [section 13.1](#).

#### Accepted products

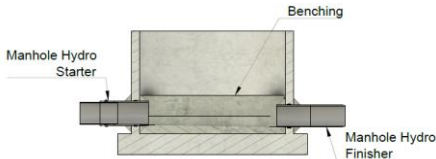
Product model/name	Image	Manufacturer/supplier	Specific limitation
1580 Manhole connector		Solo Plastics	Local networks – wastewater
DWV junctions (ID, EDJ, DJ)			
Z1500HF			

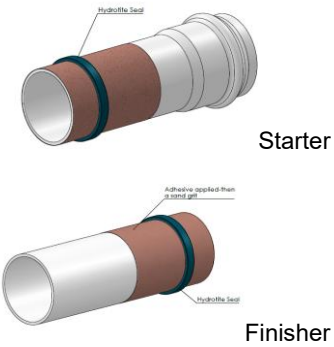
Product model/name	Image	Manufacturer/supplier	Specific limitation
Manhole Invert Connector		Mico	Local networks - wastewater
VC with PVC short		Hynds/Hygrade	Local networks – wastewater
Manhole starter 1582.xxx(pipe OD) manufactured from SN16		Strata plastics	Local networks wastewater for use with PVC pipe – <b>Starter piece only</b>
Manhole finisher 1585.xxx(pipe OD) manufactured from SN16		Strata plastics	Local networks wastewater for use with PVC pipe - <b>Finisher piece only</b>
Manhole connectors for PE, 1588.xxx(Pipe OD) manufactured from SN16		Strata plastics	Local networks wastewater for use with PE pipe. Finish and starter connected through to benching – benching to be made good.
Sliding Manhole joint		Asmuss	Local networks – wastewater
PVC manhole starter and finisher		Aquafit	Networks – starter and finisher

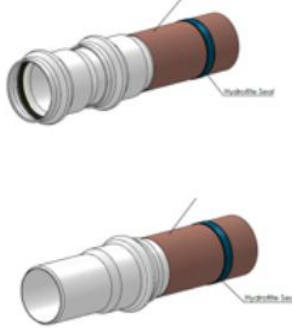
Product model/name	Image	Manufacturer/supplier	Specific limitation
Ecoplas hydrotite manhole starter and finisher including pipe short		Aquafit	Local networks-wastewater

## 13.9 Pumps

### 13.9.1 Grinder pumps for private sewer application

Applies to pumps for use in pressure wastewater collection (PWC) / low pressure sewer (LPS) systems

#### General requirements



- a) Pumps shall be selected for the specific application where a minimum of 0.4 L/s is achieved at the pressure wastewater system average operating head. The pump's maximum operating head for short periods shall exceed the pressure system maximum head by minimum 10%.
- b) Pumps shall be fitted with a 240v, 50 Hz single phase motor meeting AS/NZS 3000 requirements and rated IP68. Refer to [section 13.13.7](#) for motors.
- c) The grinder low pressure pumping system shall comply with NSF/ANSI 45 and fittings with the respective section in this standard.
- d) Fittings shall be minimum PN16 rated and selected to prevent environmental and galvanic corrosion
- e) The minimum pipework size shall be 32mm internal diameter.
- f) Overload/over-pressure protection at maximum shut-off head.
- g) The grinder cutter shall be a single piece stainless steel hardened to 57-60Rc.
- h) Tanks shall comply with AS/NZS1546.1 with minimum 24 hours storage capacity above the high-level alarm level activation point for the unit it is serving. (min. 660 litres for a standard domestic dwelling).
- i) Tanks in trafficable areas shall comply with the level of traffic expected as per AS3996 or EN124.
- j) Tank covers shall comply with [section 13.8.1](#). Non-trafficked areas shall be rated for minimum 500kg. Access cover shall be child proof.
- k) The control panel shall be minimum IP65 rated and provided with lockable access security.
- l) Control panels shall be fitted with a suitable emergency generator connection.
- m) Alarms shall be audible and visual with minimum:
  - High level alarm
  - Pump fault or conditions preventing pumping operation
  - Alarms reset automatically after issue resolution
  - Button on the panel to silence audible alarms
- m) Maintenance manuals, control diagrams and wiring detail, installation and commissioning manuals, drawings and homeowner's manual shall be stored in a purpose compartment in the control panel.

### Quality Control

- a) All products shall be marked in accordance with the conformity assessment body's requirements.
- b) The product shall have a minimum 2-year manufacturer's warranty, completed with each installation.
- c) Product certification (ISO Type 3 or 5) to NSF/ANSI 46.
- d) Polymeric coatings shall have product certification (ISO Type 5) to AS/NZS 4158.

### Accepted products

Product model/name	Image	Manufacturer/supplier	Specific limitation
OGT		Aquatec	System head 40m at 0.5l/s. <b>Note design limitations for new systems in CoP</b>
E-One		E-One / Ecoflow	System head 55m at 0.4l/s. <b>Note design limitations for new systems in CoP</b>

Product model/name	Image	Manufacturer/supplier	Specific limitation
InviziQ		Mono	System head 45m. <b>Note design limitations for new systems in CoP</b>
OGP		Aquatec	System head 40m at 0.5l/s. <b>Note design limitations for new systems in CoP</b>
GP2		Sabre	System head 60m at 0.4l/s. Use Rational Method or Dynamic Hydraulic modelling when sizing pump. Not Probability Method. Distribution board circuit breaker to be rated for pump motor size. <b>Note design limitations for new systems in CoP</b>

Product model/name	Image	Manufacturer/supplier	Specific limitation
<p>Xylem Pressure sewer pump 3068PSS</p>		<p>Xylem</p>	<p>System head 60m at 0.4l/s. <b>Note design limitations for new systems in CoP</b></p>

## 13.9.2 Submersible pumps for sewer pumping stations

### General requirements

- a) Refer to [section 13.13.7](#) for motors.
- b) The impeller type shall be selected specifically for the design or operational application, taking into consideration the best efficiency requirements as specified by the design.
- c) Pumps 30kW and over shall have vibration monitoring unless otherwise specified by design.
- d) For all Submersible pumps up to 7.5kW:
  - i. Motors shall be supplied with an integral vendor cable(s) which will be connected to a junction box located as close as possible to the motor (i.e. at the top of the pump guide bars). The junction box shall house fixed terminals for the connection of field wiring. Floating connections are unacceptable.
  - ii. All submersible pumps shall be provided with monitoring of winding temperature and moisture ingress as a minimum. Moisture ingress via cable or cable gland and also moisture ingress via mechanical seals must be monitored and alarmed prior to moisture making it to the stator windings.
  - iii. Each pump unit shall be provided with suitable relay devices, fully compatible with the detection probes supplied and with fully detailed wiring and connection details. All such relays and associated components shall be readily available in New Zealand. Relay devices shall be housed in field control enclosure.
- e) Conformance with WSA101:2008 industry standard for submersible pumps for sewage pumping stations amended as follows:

Clause	Amendment
2.1	Paragraph 1, delete: "See Appendix B for alternative materials"
	Replace Note with "Material alternatives will be considered by Watercare standards governance group or as may be nominated by the Standards Engineer"
2.4	Paragraph 4, delete: "hot-dip galvanized to AS/NZS 4680"
	Delete "Note: Other protective... may be acceptable"
Table 2.1	Delivery hose minimum grade "Class C rated to 10 bar" replace with "16 bar"
3.7.1	Notes, replace "a ruling committee of asset owners and operators selected by the Water Services Association of Australia (WSAA)" with "Watercare Services Ltd"
3.7.2	Note, replace "a ruling committee of asset owners and operators selected by the Water Services Association of Australia (WSAA)" with "Watercare Services Ltd"
3.7.3	Delete clause (b)
3.7.7.1	Delete clause 3.7.7.1 Insert: "Electrical Motors shall comply with the requirements as specified by Watercare electrical standards"
3.7.7.6	Last paragraph "of 15 m" , replace with "up to the maximum depth of the manhole wet well plus 5 m"

Clause	Amendment
3.8.1	Delete “Note:...”
3.9.1	Delete clause 3.9.1
3.9.5	Replace “Flange gaskets... WSA 109.” with “Flange gaskets shall comply with Watercare’s general mechanical construction standard. O-rings shall comply with AS1646.”

**Quality Control**

- a) All products shall be marked in accordance with the conformity assessment body’s requirements.
- b) As specified by the Watercare standard for Local Network Wastewater Pumping Station Design and Construction, and WSA101:2008.
- c) Certificate of compliance (ISO Type 5) to AS2417 or ISO 9906.

**Procurement schedule**

- a) Complete schedule: WSA101:2008, Appendix C.

**Accepted products**

Manufacturer/supplier	Specific limitation
Grundfos	Design specific
Flygt	Design specific
KSB	Design specific
Sulzer	Design Specific

### 13.9.3 Pumps for water supply and wastewater dry mounted.

#### **General requirements**

- a) Minimum working pressure shall be PN16.
- b) Pumps 30kW and over shall have vibration monitoring unless otherwise specified by design
- c) Pumps shall comply with:
  - WSA 130:2010 for pumps
  - WSA 131:2010 for motor pumps

#### **Quality Control.**

- a) All products shall be marked in accordance with the conformity assessment body's requirements.
- b) Product certification (ISO type 3 or 5) to WSA 131:2010 or WSA 130:2010 as respectively applicable.
- c) Certificate of compliance (ISO Type 5) to AS2417 or ISO 9906.

#### **Procurement schedule**

- a) For pumps complete schedule: WSA130:2010, Table C.1.
- b) For motor pumps complete schedule: WSA131:2010, Table D.1.

#### **Accepted products**

Manufacturer/supplier	Specific limitation
Grundfos	Design specific
Flygt	Design specific
KSB	Design specific

### 13.9.4 Dewatering pumps for chambers

Chamber dewatering pumps shall not be used for wastewater pumping.

#### **General requirements**

- a) Motor casing shall be stainless steel 304 (or better), or cast iron
- b) The pump motor shall be single phase 50Hz
- c) The pump impeller shall be stainless steel 304 (or better), or hard cast iron
- d) Pump shaft shall be stainless steel 304 or better
- e) All surfaces not made of stainless steel and susceptible to corrosion shall be epoxy coated to AS/NZS4158
- f) All fasteners shall be stainless steel A2 or A4
- g) Inlet strainer shall be stainless steel 304 or better
- h) Pump discharge size shall be 50mm
- i) Pump must be able to deliver 200 litres per minute and a minimum 10 metre pumping head
- j) Pump start and stop shall be with a paddle float
- k) The pump motor shall have built in thermal overload protection
- l) Motor seals shall be double mechanical seals in separate oil filled chamber

#### **Quality Control**

- a) The product shall have a minimum 2 year manufacturer's warranty, completed with each installation.
- b) Polymeric coatings shall have product certification (ISO Type 5) to AS/NZS 4158.

#### **Standardised products**

Product model/name	Manufacturer/supplier	Specific limitation
Elepon AD450 S	Elepon	Single phase
Elepon AD250 2S	Elepon	Single phase - for standard use in BSP chambers
SFA-0512N	Showfou	Single phase

## 13.10 Corrosion protection

### 13.10.1 Corrosion protection tapes – cold applied and prefabricated





#### General requirements





- Applicable standards are: ANSI/AWWA C209; ANSI/AWWA C214; ANSI/AWWA C217.
- The coatings shall be applied in accordance with the manufacturer's requirements or as otherwise specified.





#### Quality Control

- Product certification to: ANSI/AWWA C209; or ANSI/AWWA C214; or ANSI/AWWA C217 as applicable to the application method.

#### Accepted products

Product model/name	Image	Manufacturer/supplier	Specific limitation
Primer - 1027		Polyken	Steel or DI pipe only – not plastic or rubber in joint application.
UCC Butyl Mastic Strip		UCC	
942, buried and above ground		Polyken	Transitioning sections and field joints  Steel, DI and PE connections. All pipe types (butyl)
955		Polyken	Mechanical protection layer
SFL Rockshield		Polyken	Over full system for mechanical protection.
UCC RockMesh		UCC	

Product model/name	Image	Manufacturer/supplier	Specific limitation
<p><b>Component One</b> – Denso M.P Primer</p>		<p>Denso</p>	<p>Apply a thin uniform coat of Denso M.P Primer to entire surface with gloved hand, brush or rag</p>
<p><b>Component Two</b> – Denso Profiling Mastic</p>		<p>Denso</p>	<p>Mold the Profiling Mastic to a rounded configuration to fill irregular shapes and reduce sharp edged surfaces</p>
<p><b>Component Three</b> – Denso Tape</p>		<p>Denso</p>	<p>Spirally wrap the tape with a 55% overlap. Whilst wrapping, press out air pockets and smooth all lap seams.</p>
<p><b>Component Four</b> – Denso PVC SA Tape</p>		<p>Denso</p>	<p>Spirally apply the Denso PVC SA Tape over the Denso petrolatum Tape at a 55% overlap to mechanically protect the system. Apply sufficient tension to provide continuous adhesion of the tape.</p>

Product model/name	Image	Manufacturer/supplier	Specific limitation
UCC petrolatum wrapping system		UCC	
ViscoSeal		UCC	Corrosion protection for aboveground pipework (by design). This product can be coated with paint.
Trenton wax tape #1		Industrial Solutions Ltd. Gasket	Buried applications. Anti-corrosion wrap with Temcoat Primer and overwrap.
Trenton wax tape #2		Industrial Solutions Ltd. Gasket	Aboveground applications. Anti-corrosion wrap with Temcoat Primer and overwrap.

### 13.10.2 Corrosion protection – fusion bonded polyethylene coatings

#### General requirements

- c) Applicable standard: AS 4321
- d) The coatings shall be applied in accordance with the manufacturer's requirements or as otherwise specified.

#### Quality Control

- b) Product certification to: As applicable to the application method and carried out by certified applicators.

**Accepted products**

Product model/name	Image	Manufacturer/supplier	Specific limitation
Sintakote		SteelMains / Olsen's Welding	Steel pipe

**Accepted repair products**

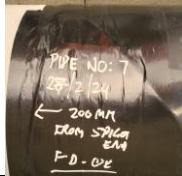
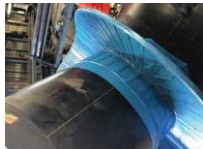
Product model/name	Image	Manufacturer/supplier	Specific limitation
Canusa KLON heat shrink sleeve		UCC	Steel pipe joint reinstatement or repair
Canusa CRP65 repair patch		UCC	Steel pipe Sintakote coating repair
Canusa WRAPID BOND Visco Elastic Tape		UCC	Complex fittings where Sintakote is not achievable or coating repairs

**13.10.3 Painting systems for pipe and equipment protection**

**General requirements**

- For heavily abrasive applications such wastewater pump header manifolds Belzona 5821 shall be specified.
- Alternative coating systems may be specified to meet project specific requirements; however this must be done in consultation with Altex.
- Alternative coatings must be selected specific to design and performance.
- Coating environments are as based on table 2.1 of AS/NZS 2312.1
- Material Safety Data Sheets (MSDS) sheets are available from the suppliers at <https://altexcoatings.com/datasheets>

- f) Project specific, specialist applications or repair specifications must be determined in consultation with Altex Coatings. Contact either Altex Coatings technical team or your local Altex Coatings representative - refer contact details below.

### **Altex Coating Ltd – Contact information**

#### **Head Office, Technical Support & Manufacturing Plant**

91-111 Oropi Road, Greerton  
P O Box 142, Tauranga 3144  
New Zealand  
Phone: +64 7 541 1221  
Technical Help Line: 0800 258 390  
Email: [Support@Altexcoatings.co.nz](mailto:Support@Altexcoatings.co.nz)

### ***Project schedule***

The following information shall be presented to Altex prior to the selection of the coating system

#### **a) *Environment and job specific requirements***

The projects' atmospheric corrosivity environment shall be based on ISO 9223, reflected in AS/NZS 2312 Table 2.1 and evaluated in consultation with Altex.

#### **b) *Substrate***

Different substrates require different preparation and/or coatings. The standard specifications (existing coating systems) are a mixture of new mild steel and galvanized steelwork applications.

#### **c) *Protection requirements***

Durability's for coating systems is based on AS/NZS 2312.1 and are listed in the specification guide, for Life to first major maintenance outside these duration periods.

#### **d) *Classification of system (standard or high-risk)***

Standard systems are designed for the non-critical areas where coatings can be applied by a competent applicator. High risk systems require knowledge of the products and the environment where the coating will be used. High risk systems or areas include temperatures outside of normal ambient conditions, potable water or other primary containment applications.

Alternative specifications can be written in consultation with Altex for project specific coatings systems designed for high levels of protection. These systems include protection for chemicals in low and high concentrations, high temperatures, high levels of H<sub>2</sub>S, intumescent fire systems, flooring and other specific scenarios and will be written as required.

#### **e) *Application – new steelwork or re-applying coating system to existing steelwork***

The existing coating systems are designed for new steelwork. Minor repairs to coating systems can be repaired by following the instructions on the specifications provided by Altex.

For repainting of degraded paint systems, contact Altex to determine the most suitable specification.

**Table 1:** Project engagement schedule

## **Project Schedule**

1 Project Description		
<p><u>Scope:</u> Each project is assigned a unique reference number. The project description includes details on project name, area location, size, process conditions, environmental classification, new or repair work, and a cross-reference that tracks revisions and modifications.</p>		
1.1 Project		
Project Number		
Project Name		
Equipment Numbers		
Documentation No		
Area Location		
Description		
Size		Area (m <sup>2</sup> )/Vessel diameter x height/ length
Substrate		Steel/ Galvanised/ Stainless steel Concrete (poured, spun, block)
Drawings (list numbers)		
Environment		Interior/ Exterior/ Insulated/ Buried/ Damp Immersed
Process stream		Potable water/ Raw sewage/ Treated sewage
Temperature		°C
Pressure		bar
Type		New/ Repair/ Repaint/ Removal
Durability		Years
1.2 Tanks		
Diameter		m

Height/ Length		m
<b>1.3 Pipework / equipment</b>		
Diameter		m
Length		m
Connection		Flanged/welded
<b>2 Personnel</b>		
<u>Scope:</u> Contact names of project managers, supervisors, and suppliers		
Project manager		
Consultant		
Supervisor		
Coating supplier		
NCI Coating inspector		
Contractor 1		
Contractor 2		
<b>3 Revision/ Project modifications</b>		
<u>Scope:</u> Track updates and plant modifications		
Date/ Revision		
Date/ Modification		
<b>4 Environment</b>		
<p><u>Scope:</u> Environmental data is classified into six groups.</p> <p>4.1 Exterior macro climatic conditions</p> <p>4.2 Corrosivity data evaluation (BRANZ and NIWA data)</p> <p>4.3 Under insulation</p> <p>4.4 Buried</p> <p>4.5 Damp/condensing</p> <p>4.6 Immersed/ Semi-immersed</p>		
4.1 Exterior climatic data		

Air temperature range		°C
Substrate temperature		°C
Dew point		°C
Humidity range		%RH
Prevailing wind		Direction
Wind Speed		km/h
Height (above sea level)		m
Coastal proximity		km (distance to coast)/ Inland/ Splash zone/
Geothermal proximity		Nil activity/ km (distance to site)
Background H <sub>2</sub> S level		ppm
<b>4.2 Environmental corrosivity classification evaluation</b>		
Refer Table 2 below		
Macro evaluation		µm <sub>Fe</sub> / year
Macro Category		ISO 9223, C1-C5
Micro evaluation		µm <sub>Fe</sub> / year
Micro Category		ISO 9223, C1-C5
<b>4.3 Under insulation environmental data</b>		
Temperature range		°C
Corrosivity evaluation		µm <sub>Fe</sub> / year
<b>4.4 Buried environmental data</b>		
Temperature range		°C
Aggregate type		
Depth		m

Soil Resistivity		Ohm-m
Corrosivity evaluation		$\mu\text{m}_{\text{Fe}}$ / year
4.5 Damp/ condensing		
Process stream temp		$^{\circ}\text{C}$
Substrate Temperature		$^{\circ}\text{C}$
Dew point		$^{\circ}\text{C}$
Corrosivity evaluation		$\mu\text{m}_{\text{Fe}}$ / year
4.6 Immersed or semi-immersed environmental data		
Process stream		Potable water/Raw sewage/Treated sewage
Temperature range		$^{\circ}\text{C}$
pH		
H <sub>2</sub> S		ppm
CH <sub>4</sub>		ppm
Corrosivity evaluation		$\mu\text{m}_{\text{Fe}}$ / year

**Table 2:** Atmospheric evaluation

Table 2 Atmospheric Macro/ Micro Corrosivity Evaluation						
Macro Climate						
Region		BRANZ Data			HERA Data	
Site Location		Location	g/m <sup>2</sup> / year	$\mu\text{m}$ / year	Minimum ( $\mu\text{m}$ / year)	Maximum ( $\mu\text{m}$ / year)
Coastal proximity						
Wind speed						
Wind direction						

Humidity		Average			
<b>Estimated Macro Climate</b>		<b>Corrosivity</b>		<b>Category</b>	
<b>Micro Climate</b>					
<b>Item</b>		<b>+ Factor</b>	<b>X Factor</b>	<b>Accumulated Corrosivity</b>	
Damp/ shade					
Semi enclosed					
Unwashed saline					
Bird lime/ lichen					
Geothermal					
Transport fumes					
<b>Estimated Micro Climate</b>		<b>Corrosivity</b>		<b>Category</b>	

### Existing coating systems

**Note:** The listed coating systems are a general coating system index. Selection must be supported with completion of the above project schedule and confirmed with Altex.

Coating System		Application and Environment		
Ref No	Altex Specification No.	Designated Area (AS/NZS 2312 System Classification)	Environment Corrosivity	ISO 12944 Durability
01	TG-2024-179674	Interior and Exterior surfaces: Pipework, valves, pumps, pipe bridges, tank exteriors, structural steelwork, machinery guards, staircases, exposed to UV areas (PUR 4)  <b>(Mild Steel)</b>	C3	C3 15-25 years
02	TG-2024-179686	Interior and Exterior surfaces: Pipework, valves, pumps, pipe bridges, tank exteriors, structural steelwork, machinery guards, staircases, exposed to UV areas (PUR 5)  <b>(Mild Steel)</b>	C4 and C5	C4 25+ years C5-M 15-25 years
03	TG-2024-179679	Interior and Exterior surfaces: Pipework, valves, pumps, pipe bridges, tank exteriors, structural steelwork, machinery guards, staircases, exposed to UV areas (HDG600 2D)  <b>(Galvanised Steel)</b>	C4	C3 10-15 years for liquid applied coating C4 5-10 years for liquid applied coating
04	TG-2024-179676	Interior and Exterior surfaces: Pipework, valves, pumps, pipe bridges, tank exteriors, structural steelwork, machinery guards, staircases, exposed to UV areas  <b>(Mild Steel / Galvanised Steel)</b>	C3	C3 15-25 years
05	TG-2024-179675	Conveyors, chutes, high abrasion areas. Direct to metal – high build epoxy.  <b>(Mild Steel)</b>	High abrasion	-
06	TG-2024-179683	Wastewater/ fresh water/ stormwater internal lining, immersed	immersion wastewater/ freshwater/ stormwater	Immersed 10+ years
07	TG-2024-179680	Buried Steelwork and pipework in Sand, damp aggregate soil or concrete  <b>(Mild Steel)</b>	Buried high corrosive environments	Immersed 10+ years
08	TG-2024-179685	Flooring with non-skid areas	Flooring <50m <sup>2</sup> , for greater than	-

Coating System		Application and Environment		
Ref No	Altex Specification No.	Designated Area (AS/NZS 2312 System Classification)	Environment Corrosivity	ISO 12944 Durability
		<b>(Concrete)</b>	this area other products are available	
09	TG-2024-179677	High temperature, non-insulated pipework. Requires heat cure <b>(Mild Steel)</b>	Temperatures 204°C to 538°C	-
10	TG-2024-179678	Cryogenic to 650°C, cyclic temperatures, suitable under insulation. Requires heat cure. <b>(Mild Steel)</b>	Temperatures - 196°C to 650°C	-
11	TG-2024-179681	Potable water applications, immersed to contact, Internal lining of pipework, Internal pipe spools, Tank Linings, immersed steelwork to 23°C <b>(Mild Steel)</b>	Potable water contact or immersion	Immersed 10+ years
12	TG-2024-179682	Potable water applications, immersed to contact, Internal lining of pipework, Internal pipe spools, Tank Linings, immersed steelwork to 23°C <b>Extended durability</b> <b>(Mild Steel)</b>	Potable water contact or immersion	Immersed 10+ years
13	TG-2024-179684	Sealant system for concrete wet wells, manholes, sumps, exterior buried and internal lining, pH 4-8 to 40°C, CLP systems <b>(Concrete)</b>	concrete substrate, immersion in wastewater <2ppm H2S	Immersed 10+ years

## 13.11 Cathodic protection

### 13.11.1 Cathodic protection anodes

#### Impressed current anodes

Shall be ordered as per the design and shall be mixed metal oxide coated titanium or silicon cast iron cathodic protection anodes, rated for 50+ years operation.

#### Sacrificial anodes

- a) Meet AS2239 Galvanic (sacrificial) anodes for cathodic protection.
- b) Be pre-packaged in gypsum-bentonite in accordance with the standard.
- c) Be as specified in the design.
- d) Sized for the application to allow a minimum design life of 25 years for magnesium anodes, and 50 years for zinc anodes.

#### Shunts for current measurement

- a) Issued with a certificate of calibration.
- b) Clearly marked with calibrated resistance.
- c) 0.01ohm for impressed current anode cables.
- d) 0.1ohm for sacrificial anode cables.

#### Switches for manual interruption of bond current

- a) Rated for minimum twice the design current.
- b) Normally closed.
- c) Momentary action.
- d) IP68 rated when located underground, IP56 when located above ground. Protection can be provided by installing the switch within an appropriately rated enclosure and using appropriate glanding.
- e) Rated for 1,000,000 cycles.

### 13.11.2 Cathodic protection Zinc reference

Shall be Anode Engineering AEZR-1, or equivalent, and shall be:

- a) Pre-packaged zinc electrode.
- b) Designed for use as a permanent buried reference electrode.
- c) Supplied with calibration certificate.
- d) Rated for operation for longer than 30 years.

### 13.11.3 Cathodic protection – Electrical probes and corrosion coupons

Corrosion coupons shall be Rohrbak Cosasco Systems; Smart Test Station ER Probes. Ordered as 'foot only,' to be installed with the specified test station.

- a) Normal installation is without an in-built reference. Ordering code is:
  - STF-1-LL, where LL is the length of cable in feet, 1 metre = 3.3 feet
- b) Where the design specifies supply with an in-built reference the ordering code is:
  - STF-0-LL, where LL is the length of cable in feet, 1 metre = 3.3 feet

### 13.11.4 Cathodic protection flange insulation kits

- a) Whether a flange gasket is required and whether it is to be potable or wastewater rated.

- b) Number of sleeves and washers.
- c) Mylar, or better, sleeve, and inner and/or outer diameter.
- d) Sleeve length, enough to overlap midway into both steel washers.

### 13.11.5 Cathodic protection monolithic insulation joints

- a) Be suitable for the application.
- b) Any component or lubricant in contact with the water supply shall comply with AS/NZS 4020.
- c) Internal lining shall be dielectric and extend for a length equivalent to at least one diameter on both sides of the insulation.
- d) A proposal for the joint to be ordered shall be presented to Watercare for approval prior to placing order.

### 13.11.6 Cathodic Protection test stations

Pillar mount test stations are preferred over flush mount. Flush mount shall only be ordered for sites where a pillar would block access or traffic and where wall mounting is not suitable.

Preferred types for urban, suburban and semi-rural use, in order of preference are:

- Watercare Standard Transnet Ecopillar
- Wall mounted
- Watercare Standard Transnet TUD pit
- Flush Fink

For Rural use Big Fink pillar test points may be used in place of Transnet Ecopillars.

Wall mounted enclosures may be used where it is practical to mount the test station on a Watercare building. The enclosure ordered shall be as specified in the design or if not specified shall suit the site conditions, be sufficiently vandal proof, include non-conductive or insulated mounting plates and be of a suitable size to accommodate the required fittings.

Ordering information:

Test Station Type	Order Code / Detail	Supplier
Ecopillar	EP0WSLSTD	Ideal Electrical
TUD pit	Watercare Std TUD pit	Ideal Electrical
Flush Fink	Black	Cathodic Protection New Zealand Ltd
Big Fink	Dark green	Cathodic Protection New Zealand Ltd

### 13.11.7 Cathodic protection power supplies

- a) Meet New Zealand electrical regulations for extra low voltage dc power sources – including technician access to terminals for installation of a portable interrupter.
- b) Be robust and rated for 50 years operation.
- c) Include a RS485 Modbus RTU or Modbus TCP port. Modbus TCP is preferred
- d) Include a GPS synchronised interrupter, operable via the RS485 port.
- e) Have a minimum of the following output control options:
  - Constant current, and
  - Constant pipe potential (Auto-Control)
- f) Be continuously adjustable down to  $\leq 1\%$  of maximum current.
- g) Output smoothed dc - ripple to be  $\leq 5\%$  of output voltage.
- h) Include facilities for installing a portable interrupter.

### 13.11.8 Cathodic protection services

The companies listed in this section may be engaged for the service categories listed. Suppliers not listed may be used on Watercare specific approval.

#### Electrical hazard analysis

Consultants with resources to carry out electrical hazard analysis include:

- ElectroNet
- Voltoni Ltd
- Phoenix Solutions

#### Contractors and consultants

Provider	Category	CP Services
Beca	CP consultant	Design Project Management Commissioning
WSP	CP consultant	Project Management
Corrosion Control Engineering	CP consultant	Design Project Management Commissioning
Phoenix Solutions	CP consultant	Design Project Management Installation Testing
Savcor ART NZ Ltd	CP contractor & Supplier	Design Installation Testing Commissioning Equipment supply
Anode Engineering	CP Contractor	Design Installation Testing Commissioning
Ventia	Instrumentation	Installation Testing Basic design Basic commissioning
Clarkson Electrical	Instrumentation	Installation Testing
Cathodic Protection NZ Ltd	Supplier	Design Equipment supply
Deepwater Corrosion Services	Supplier	Design Equipment supply

#### Equipment suppliers

Supplier	Agents for	Equipment supplied
Anode Engineering	Various	All

Supplier	Agents for	Equipment supplied
Sulco NZ Ltd	Various	All
Savcor ART NZ Ltd	Various	All
Cathodic Protection NZ Ltd	Various	Anodes, references, TR's, FIK's and other
Lordco	Various	ER Probes, MIJ's, FIK's and other equipment
Deepwater Corrosion Services	Dairyland Electrical, and other	PCR, surge diverters, and other equipment
M Broddribb Ltd	Supplier	TR's
Metal Image Ltd	Supplier	Labels
Shuk Engineering	Various	FIK's

## 13.12 Instrumentation and control

### 13.12.1 General requirements for all instrumentation

- a) Measurement instrumentation for:
- Water meters,
  - Gas meters,
  - Active electrical energy meters,
  - Thermal energy meters,
  - Continuous and dynamic measurements of quantities of liquids other than water,
  - Automatic weighing instruments,
  - Material measures, and
  - Dimensional measuring instruments
- shall comply with Measuring Instruments Directive (MID), directive 2014/32/EU.
- b) Pneumatic receiver instruments shall accept 20kPa to 100 kPa pneumatic signals
- c) Communication protocols:
- 4 to 20mA/ (HART where available)
  - Serial: Modbus RTU, Modbus TCP (Modbus TCP is preferred)
- d) Transmitter type instruments shall have a linear 4-20mA isolated transmitted signal
- e) All loop instruments shall be suitable for 600 Ohm loops.
- f) Digital instrument signals shall be 24Vdc.
- g) Proximity switches shall be two-wire. Three-wire devices require Watercare approval.
- h) Relay outputs shall be SPDT dry contact; 2Amp (minimum); 240Vac/24Vdc.
- i) Instrumentation installed in potentially explosive/ hazardous atmospheres shall comply with AS/NZS 60079. The instrumentation must be selected in order to comply with the hazardous area classification and the design.
- j) Where applicable, all field instruments with local indication shall have an LED or LCD indicator with engineering units related to the medium being measured.
- k) Where pressure transmitters are installed, an appropriate means of isolation shall be provided to calibrate the instrument.
- l) Displays shall have enough digits to accurately display the specified measured range. Instrumentation for measurement, control and laboratory use shall comply with IEC 61326.
- m) Functional safety of instrumentation shall comply with IEC 61508 (AS 61508).
- n) Instrumentation shall be tested for electromagnetic compatibility (EMC) to AS/NZS 61000.4.7.
- o) All instrumentation shall have electrical RF and electromagnetic noise immunity.
- p) Instrument housings shall be suitable for the operating environment.

- q) Any protection required in addition to the manufacturer's standard finish shall be provided. This includes conformal coating of all electronic printed circuit boards (PCB) and components in compliance with IEC 60721 class 3C3. Class 3C2 may be provided with the approval of Watercare.
- r) Below ground instruments shall have a minimum IP rating of 67, while all other instruments shall be a minimum of IP65 rated unless otherwise specified.
- s) Programmable instruments shall:
  - i. Be provided with a simple means for configuring operating parameters
  - ii. Have security features which prevent unauthorised access/modification
  - iii. Use only English words and the English language for display and configuration
- t) Data sheets shall be provided for any instrument accessories. The fail-safe state of any switched contacts must be detailed on the data sheets.
- u) Manufacturer and product information must be engraved on a 316 stainless steel nameplate permanently fixed to the instrument.
- v) All instrument specifications, installation instructions and operation and maintenance manuals shall be provided with the instrument and shall use the English language.

**Standardised products (general) - Instrumentation**

Product Model/Name	Manufacturer/Supplier	Specific limitation / Area of use
<b>Actuators – Air</b>		
Joucomatic	ASCO / Custom Controls	
Keystone	Keystone Tyco / Custom Controls	
Fisher	Custom Controls	
SMC Actuators	SMC	
Norgren	IMI Norgren	
Prisma	Asmuss	
EL-O-Matic	Custom Controls	
<b>Chlorine Analyser</b>		
HACH CL17SC	Hach Pacific	
Evoqua - Deoplox 400M	Filtec	
Endress & Hauser CM444 Liquiline Transmitter, CCS142D CL2 Probe, CPS11D pH Probe, CCA250 Flow Cell	EMC Industrial Group	
Swan AMI Trides	Swan Analytical	
<b>Gas detection</b>		
Evoqua	Filtec	Chlorine
Crowcon Gas Detection Instruments	Instrumatics	

Product Model/Name	Manufacturer/Supplier	Specific limitation / Area of use
Honeywell Instruments	NZ Safety	
<b>Differential Pressure</b>		
Rosemount 3051 series	Emerson Management/ Controls	Process Custom
Endress & Hauser DeltaBar	EMC Industrial Group	
Yokogawa	Yokogawa	
<b>Distributed Control System</b>		
Delta V with AMS installed	Emerson Management	Process
<b>Dissolved Oxygen</b>		
Endress & Hauser OxyMax COS61D with CM444 transmitter	EMC Industrial Group	
Xylem WTW FDO 700 IQ – Dissolved oxygen sensor	Xylem	
<b>Dosing Pumps</b>		
Milton Roy	Foster & Associates	
Wallace and Tiernan - Evoqua	Filtec	
Bran & Leubbe	Pump Systems	
Prominent	Chemical Feed Solutions	
Grundfos	Grundfos	
<b>Flow Switches – Instrument Sample Lines</b>		
VGfVASK510 - 15mm Variable Area Flowmeter with magnet	Plastic Systems	5-50 l/hr
VGfVASK620 - 15mm Variable Area Flowmeter with magnet	Plastic Systems	20-200 l/hr
VGfVAGK11 – Max Limit Contact (Fail safe for FSL)	Plastic Systems	
Endress & Hauser DMA15 (Picomag)	EMC	
<b>Flow Switches Pumps</b>		
Flow Captor	EMC	
IFM Flow switch with tap	IFM	

Product Model/Name	Manufacturer/Supplier	Specific limitation / Area of use
<b>Fluoride analyser</b>		
ABB Aztec 600	ABB Ltd	
<b>Inductive proximity switches</b>		
IFM	IFM Effector Pty Ltd	
Pepperl + Fuchs	Customs Controls Ltd	
Turck BI15-CP40-AP6X	CSE-W. Arthur Fisher Ltd	
<b>Instrument valves</b>		
Woscester/Norbro/Norgren	Delta	
<b>Level control relays</b>		
Multitrode (24 VDC powered)		
Omron 61FGPN (24 VDC Powered)		
<b>Level switches</b>		
Vega	Instrumatics	
ATMI	Instrumatics	
Endress & Hauser Liquiphant	EMC Industrial Group	
Endress & Hauser Liquipoint	EMC Industrial Group	
Flygt	Xylem	
IFM	IFM	
<b>Level transmitters (hydrostatic)</b>		
Endress & Hauser FMX 21	EMC Industrial Group	
VegaBar 80-series; VegaWell 52	Instrumatics	
<b>Level transmitters (radar)</b>		
Vega Vegapuls Series C21, C23, Puls21 (compact version)	Instrumatics	
Vega Plus C Series with Vegamet (for remote mount installations)	Instrumatics	
VegaPuls6X	Instrumatics	Process radar; not for wet well applications
Emerson Rosemount 1208 (compact version); 3408	Custom controls	Process radar; not for wet well applications

Product Model/Name	Manufacturer/Supplier	Specific limitation / Area of use
FMR 60B, 62B	EMC	Process radar; not for wet well applications
<b>PH/ (Redox) ORP meters</b>		
ABB AP100 (and APS500) with AWT420 transmitter	ABB Ltd	
Hach	Filtec / Hach Pacific	
Rosemount	Fisher-Rosemount / Custom Controls	
Endress & Hauser CPS11D with CM444 transmitter	EMC Industrial Group	
<b>Pressure Switches</b>		
Danfoss	Danfoss	
Endress & Hauser Ceraphant	EMC Industrial Group	
IFM	IFM	
SMC	SMC	
United Electric	Applied Instruments	
VegaBar Series	Instrumatics	
<b>Pressure Transmitters (with block and bleed valves for isolation and removal during calibration and testing of equipment)</b>		
Rosemount 3051 series or 2088 series	Emerson Process Management	Series selected on accuracy requirements
Vegabar series	Instrumatics	
Endress & Hauser Cerabar Series	EMC Industrial Group	
<b>Process Indicators</b>		
Endress & Hauser RIA series	EMC Industrial Group	
Vega VegaMet Series	Instrumatics	
<b>Sludge Thickness in line meter</b>		
Endress & Hauser TurbiMax CUS51D with CM444 transmitter	EMC Industrial Group	
<b>Solenoid valves</b>		
Joucomatic	ASCO	

Product Model/Name	Manufacturer/Supplier	Specific limitation / Area of use
Burkert	Burkert fluid control	
SMC	SMC Corporation	
<b>Streaming Current</b>		
Chemtrac	Liquipro	
Milton Roy	Liquipro	
Hach AF7000	Hach Pacific	
<b>Temperature Transmitters</b>		
Endress & Hauser iTemp	EMC Industrial Group	
Rosemount 644	Custom Controls	
IFM	IFM	
<b>UV Transmissivity</b>		
Endress & Hauser ViaMax CAS51D with CM444 transmitter	EMC Industrial Group	
SWAN SAC254	SWAN Analytical	
WTW IQ Sensor UVT	Xylem	
<b>Weighing Systems</b>		
Wedderburn, GEC, Avery	Wedderburn, GEC, Avery Weigh-Tronix	
EMC Modweigh - Chlorine Drum Weighers	EMC Industrial Group	
Forceflow – Chlorine drum weighing system	Filtec	

**Standardised product – Digital Products**

Product type	Product Model/Name	Manufacturer/Supplier	Specific limitation / Area of use
<b>Controllers</b>			
RTU Hardware	Ovarro / Kingfisher Series III	CSE-W. Arthur Fisher Ltd	For part number list refer to ESF-500-STD-407
PLC Hardware	Rockwell / CompactLogix, ControlLogix	NHP	For part number list refer to ESF-500-STD-408

Product type	Product Model/Name	Manufacturer/Supplier	Specific limitation / Area of use
<b>Network Switches</b>			
Network Switches	Various Cisco, Aruba, Stratix, Moxa & Nozomi Switches and appliances		For part number list refer to ESF-500-STD-404
<b>Industrial HMIs</b>			
HMI / Graphical Display	RedLion / CR30001500000420	CSE-W. Arthur Fisher Ltd	Only use the model indicated. Do not replace with any variant of the CR3000 product line. Use this model in pump stations and headwork sites
HMI / Industrial PCs	VECOW-SPC-3520-955U	Engineering Computer Services (ECS)	Use this model in radio repeater sites. Compatible Vecow memory modules and SSD must also be purchased for a complete system (VECOW-DDR4-8GB, VECOW-SSD240-SATA-A)
HMI / Industrial PCs	VECOW-SPC-7100-1145G	Engineering Computer Services (ECS)	Use this model in treatment plants. Compatible Vecow memory modules must also be purchased for a complete system (VECOW-DDR4-16GB-WDTMP) VECOW-Din-kit-SPC-3/5/7
HMI / Industrial PCs	Winsonic WIN-PM1565-WH25L0	Engineering Computer Services (ECS)	Used together with VECOW-SPC-7100-1145G
<b>Data Radio Systems</b>			
UHF Radio Hot Standby Base Station	Trio (Schneider Electric) / QH Range TBURQH4HN-E00E1L0A	CSE-W. Arthur Fisher Ltd	
UHF Radio Remote	Trio (Schneider Electric) / QR Range TBURQR4HH-E00E2L00	CSE-W. Arthur Fisher Ltd	
VHF Radio Hot Standby Base Station	Trio (Schneider Electric) / QH Range TBURQH1MN-E00E1L0E	CSE-W. Arthur Fisher Ltd	
VHF Radio Remote	Trio (Schneider Electric) / QR Range TBURQR1MH-E00E2L00	CSE-W. Arthur Fisher Ltd	

Product type	Product Model/Name	Manufacturer/Supplier	Specific limitation / Area of use
UHF Radio Point to Point	Trio (Schneider Electric) / QP TBURQP4HN-E00E110D	CSE-W. Arthur Fisher Ltd	
<b>Gateways and Remote IOs</b>			
Gateway - Ethernet IP to Modbus	MOXA / MGATE 5105-MB-EIP	Engineering Computer Services (ECS)	
Gateway - Modbus TCP to Modbus RTU	MOXA / MGATE 3170	Engineering Computer Services (ECS)	
Industrial M2M 4G/LTE Cellular Gateway	Teltonika / TRB256	Go Wireless NZ	Gateway to be purchased with the following accessories PR5MEC23 (DIN rail mounting kit), ANT-290 (antenna), LP-07 (Lightning Protector), P-72 (SMA Male RA to N-Male 30cm Pigtail), P-50 (N-Type Male to N-Type Male 500CM LLC400 50 Ohm Coax Pigtail)
Remote IO - Universal IO - 8DI/8DO	MOXA / R1212	Engineering Computer Services (ECS)	
Remote IO - Universal IO - 8AI	MOXA / R1240	Engineering Computer Services (ECS)	
Remote IO - Universal IO - 4AO	MOXA / R1241	Engineering Computer Services (ECS)	
<b>Power Distribution</b>			
Fuse Distribution Panel - 19"	ICT / ICT200DF-12IRC	Helios Power Solutions	
<b>Antennas</b>			
Antenna - Yagi - 3 Element	YH03 / 3 Element Yagi Antenna	RFI Technology Solutions	
Antenna - Yagi - 6 Element UHF - Stainless Steel	YBSS6-61 / Stainless Steel 6 Element Yagi Antenna (450 - 480 MHz)	RFI Technology Solutions	
Antenna - Yagi - 9 Element - UHF	YB9-61 / 9 Element Yagi Antenna (450 - 480 MHz)	RFI Technology Solutions	
Antenna - Yagi - 6 Element - UHF	YB6-61 / 6 Element Yagi (450 - 480 MHz)	RFI Technology Solutions	

Product type	Product Model/Name	Manufacturer/Supplier	Specific limitation / Area of use
Antenna - Low Profile Unity Gain - UHF	TLA400-71 / Low Profile (470 - 490 MHz)	RFI Technology Solutions	
Antenna - Monopole 6.5dB - UHF	CD93-71-70 / Monopole (470 - 490 MHz)	RFI Technology Solutions	
Antenna - Monopole 4dB - UHF	CD50-68-70 / Monopole (450 - 520 MHz)	RFI Technology Solutions	
Antenna - Monopole 3dB - VHF	CD29 / Monopole (138-166 MHz)	RFI Technology Solutions	
Antenna - Low Profile Unity Gain with Dome - UHF	TLA600-71 / Low Profile (470 - 500 MHz)	RFI Technology Solutions	
Antenna – Omnidirectional LTE/4G/5G	ANT-290 / Omnidirectional (617MHz - 6000MHz)	Go Wireless NZ	
Antenna - Omnidirectional LTE/4G/5G	ANT-288 / Omnidirectional Bulkhead Mount (697MHz - 2700MHz)	Go Wireless NZ	
Antenna - Directional Yagi - LTE/4G/5G	ANT-252 / Directional Yagi (698-960/1710-2700/3300-3800MHz)	Go Wireless NZ	
Antenna - Dome Antenna Dual Band 3DBI	ANT-37 / Dual Band Dome (2.4GHz/5GHz)	Go Wireless NZ	
<b>IoT Equipment</b>			
Flow & Pressure Measuring Datalogger	LX2 Flow + Pressure NB-IoT	HWM Global	
Flow & Pressure Measuring Datalogger	Multilog 2 Flow + Pressure NB-IoT	HWM Global	
PRV Controller and Datalogger	Pegasus 2 NB-IoT PRV Controller	HWM Global	
PRV Controller and Datalogger	Sentinel 2 NBI-IoT PRV Controller	HWM Global	
Noise Measuring Datalogger	PemaNet SU NB-IoT Noise Logger	HWM Global	

Product type	Product Model/Name	Manufacturer/Supplier	Specific limitation / Area of use
Noise Measuring Datalogger	PermaNet + NB-IoT Noise Logger	HWM Global	
Pressure Measuring Datalogger	LoLog 450 Single Channel Pressure Logger	HWM Global	
Pressure Transient Measuring Datalogger	InflowSense Pressure Transient Monitoring	Inflowmatix	
Level Measurement Datalogger	Spectra	Kallipr	
Level/Generic Measurement Datalogger	Captis S2	Kallipr	Various models available in the Captis S2 range varying in Input/Output capabilities
Flow & Pressure Measuring Datalogger	Point Orange IoT RTU	Metasphere / Pacific Technologies	

### 13.12.2 Turbidity meters

#### General requirements

- Comply with [section 13.12.1](#).
- Comply with measuring principle and performance output for BS EN ISO 7027.
- Measurement range shall be minimum 0.0001 to 1000 NTU.

#### Quality Control

- Calibration by an IANZ certified testing facility meeting ISO/IEC 17025.

#### Standardised products

Product model/name	Image	Manufacturer/supplier	Specific limitation
Endress & Hauser Turbimax W CUS51D		EMC Industrial Group	Used at plant facilities

Hach TU5300		Hach Pacific	
-------------	---	--------------	--

### 13.12.3 Meters for water supply – Volumetric and turbine type

Applies to domestic and commercial water metering

#### General requirements

- Comply with [section 13.12.1](#).
- Comply with AS 3565.1 for volumetric and turbine meters and BS EN ISO 4064 I OIML R49.
- Maximum working pressure shall be PN16.
- Refer to [section 13.4](#) for flange requirements.
- Threaded end connections shall be to BS21 / BSPP.

#### Quality Control

- All products shall be marked in accordance with the conformity assessment body's requirements.
- Meter tests shall be performed by an IANZ certified testing facility meeting ISO 17025.
- Any component or lubricant in contact with the water supply shall comply with AS/NZS 4020.

#### Standardised products

Product model/name	Description	Supplier	Specific limitation
WTMPSMT15	15mm Honeywell V100		
WTMPSMT20	20mm Honeywell V100		
WTMPSMT25	25mm Honeywell V100		
WTMPSMT30	30mm Honeywell V100		
WTMPSMT40	40mm Honeywell V100		
WTMC400050	50mm Honeywell C4000 Combination meter		
WTMC400080	80mm Honeywell C4000 Combination meter		
WTMC4000100	100mm Honeywell C4000 Combination meter		

Product model/name	Description	Supplier	Specific limitation
WTMC4200150	150mm Honeywell C4200 Combination meter		
WTMV210B4.0	4.0 Honeywell V210 (MSM-T) OIML Brass Manifold Meter		
WTMH400040	40mm Honeywell H4000 AS4087 PN16		
WTMH400050	50mm Honeywell H4000 AS4087 PN16		
WTMH400065	65mm Honeywell H4000 AS4087 PN16		
WTMH400080	80mm Honeywell H4000 AS4087 PN16		
WTMH4000100	100mm Honeywell H4000 AS4087 PN16		
WTMH4000150	150mm Honeywell H4000 AS4087 PN16		
WTMW1VFNB15	15mm Axioma Ultrasonic L110 R400 c/w extended dual check tail		
WTMW1VFNB20	20mm Axioma Ultrasonic L165 R400		
WTMW1VFNB25	25mm Axioma Ultrasonic L165 R400 inc connectors		
WTMW1VFNB32	32mm Axioma Ultrasonic L165 R400 inc connectors		
WTFENLTE	ADR nbiot clip on	Arthur D Riley	
CAPTISV100CAPTIS METRUM V100CAPTISPULLTECAPTIS PULSE LITECAPTISV100	Captis Metrum V100	Arthur D Riley	
CAPTISPULLTE	Captis Pulse Lite	Arthur D Riley	
CAPTISPULLTEEXT	Captis Pulse Lite Ext	Arthur D Riley	
V200	Honeywell Elster V200	Arthur D Riley	15mm to 40mm

### 13.12.4 Meters – electromagnetic flow type

Applies to commercial and Watercare facility water and wastewater metering.

#### **General requirements**

- a) Comply with [section 13.12.1](#).
- b) Comply with OIML R 49-1 or Measuring Instruments Directive (MID) (2014/32/EU).
- c) Meters for closed conduits shall be in accordance with BS EN ISO20456.
- d) Any component or lubricant in contact with the water supply shall comply with AS/NZS4020 or similar.
- e) Polymeric coatings shall comply with AS/NZS 4158.
- f) Conformal coating to IEC 61086-3-1, if any, must be specified to the supplier for the operating environment.
- g) Minimum working pressure shall be PN16.
- h) Refer to [section 13.4](#) for flange requirements.

**Quality Control**

- a) All products shall be marked in accordance with the conformity assessment body's requirements.
- b) Meter tests shall be performed by an IANZ certified testing facility meeting ISO/IEC 17025.
- c) Polymeric coatings shall comply with AS/NZS 4158
- d) Any component or lubricant in contact with the water supply shall comply with AS/NZS 4020.

**Accepted products**

Product model/name	Image	Manufacturer/supplier	Specific limitation
Endress & Hauser Promag W400, Model 5W4C, W800, W500. (Include 0D options)		EMC Industrial Group	Water and wastewater networks
Endress & Hauser Promag P 500		EMC Industrial Group	Chemical and process use

<p>FPI Mag  <i>(not subject to general requirements b), c), or d))</i></p>		<p>McCrometer</p>	<p>Specific applications for hot-tap metering and bulk balancing – requires specific approval by Service Delivery</p>
<p>AquaMaster FEW400</p>		<p>ABB</p>	<p>Water and wastewater networks</p>
<p>Rosemount 8700M</p>		<p>Custom Controls</p>	<p>Water and wastewater treatment plants / chemical and process use</p>
<p>ABB Aquaprobe Insertion meter</p>		<p>ABB</p>	<p>Specific applications – requires specific approval by Service Delivery</p>

Watermaster	 A photograph of a white, cylindrical flow meter with a digital display on top, mounted on a pipe. The meter has two large flanges on either side for pipe connection.	ABB	Water and wastewater networks
-------------	---	-----	-------------------------------------

## 13.13 Electrical

### 13.13.1 General requirements for all electrical components

- a) Electrical components in potentially explosive atmospheres shall comply with AS/NZS 60079. The protection method must be selected in accordance with the hazardous area classification.
- b) All electronic printed circuit boards (PCB) and components shall be provided to IEC 60721 class 3C3. Class 3C2 may be applied where approved by Watercare

#### Standardised products (general) – Electrical

Product model/name	Manufacturer/Supplier	Specific limitation / Area of use
<b>Ammeter &amp; Voltmeter</b>		
72x72mm Analogue panel mount with appropriate range	Electrical Wholesalers (refer: Procurement)	
<b>Antenna lightning protection units</b>		
RF Industries model IS-50NX-C0	RF Industries	
CRITEC CSP Series	Helios Power Solutions	
<b>Automatic transfer switch - Mains</b>		
Deep Sea DSEATs	Deep Sea Electronics	
ASCO Source Changeover Equipment	Shape Energy / Schneider Electric	
Schneider UA Controller	Schneider Electric	
Socomec ATS	Socomec	
Compact ATS, TrueONE ATS	ABB	
<b>Batteries</b>		
Yuasa (5 yr warranty) 12volt 7ah, 24ah, 38ah or 100ah sealed lead acid	Century Yuasa	
Endurant, Optima, etc brand application specific	HCB Technologies	
<b>Cabinets (networks field)</b>		
ESWC07	Cableways	Customer magnetic flowmeter sites
OPCUSW3635	Cableways	Line valve chamber control cabinet without water quality monitoring
OPCUSWE	Cableways	Bulk supply point control cabinet with water quality monitoring
<b>Circuit Breakers - MCB</b>		
Schneider iC60 series	Schneider Electric	

Product model/name	Manufacturer/Supplier	Specific limitation / Area of use
NHP Terasaki Din-T series	NHP Electrical Products (NZ) Ltd.	
ABB S200 series	ABB	
<b>Circuit Breakers - MCCB</b>		
Schneider NS/NSX series	Schneider Electric	
NHP Terasaki TemBreak 2 series	NHP Electrical Products (NZ) Ltd.	
ABB Tmax/XT series	ABB	
<b>Circuit Breakers - Motor (&lt;30kW)</b>		
Schneider GV series	Schneider Electric	
NHP Allen Bradley 140 series or Sprecher + Schuh KT-9 series	NHP Electrical Products (NZ) Ltd.	
ABB MS series	ABB	
<b>Residual Current Devices (RCD's)</b>		
Schneider Acti9	Schneider Electric	
NHP Din-Safe	NHP	
ABB	ABB	
<b>Residual Current Breakers with Overcurrent (RCBO's)</b>		
Schneider Acti9	Schneider Electric	
NHP Din-Safe	NHP	
ABB	ABB	
<b>Contactors</b>		
TeSys D, rated for AC 3 duty	Schneider Electric	
Allen Bradley 100 series or Sprecher + Schuh CA series, rated for AC 3 duty	NHP Electrical Products (NZ) Ltd.	
ABB A/AF series, rated for AC 3 duty	ABB	
<b>Current Transformers</b>		
IEX 61869-1: 2007 and BS EN 61869-2: 2012	Electrical Wholesalers (refer: Procurement)	<ul style="list-style-type: none"> <li>- Class 1 for check meter and revenue metering applications.</li> <li>- Class 3 for general purpose metering applications.</li> <li>- Class 10P for protection applications.</li> </ul> CTs shall have a 5VA minimum burden

Product model/name	Manufacturer/Supplier	Specific limitation / Area of use
<b>Electric Vehicle Chargers</b>		
EVlink Pro AC 22kw T2S 6mA MNX EVlink Pro DC	Schneider Electric	
Delta AC Max Delta DC 50kW EV Charger City CCS2 and CHAdeMO and AC T2 Socket	Delta	
X22	EVNEX	
<b>Enclosures</b>		
Himel	Schneider Electric	
Thompson Hutton	Thompson Hutton	
Eldon	NHP Electrical Products (NZ) Ltd.	
Rittal	Rittal	
<b>Equipment Labels – Metal</b>		
Aluminium Black Print	Metal Image Ltd	
<b>Equipment Labels – Traffolyte</b>		
Traffolyte	Electrical Wholesalers	
<b>E-Stop buttons</b>		
Harmony Range Lockable Flap / Cover - Part number Schneider ZB4BZ62	Schneider Electric	
Allen Bradley 800F series	NHP Electrical Products (NZ) Ltd	
<b>Fan/Light Switch Isolators</b>		
PDL 56 series	Schneider Electric	
ISO series	NHP Electrical Products (NZ) Ltd.	
<b>Harmonic filtering (active)</b>		
Sinexcel Active harmonic filter	Power electronics	
AccuSine range PCS+	Schneider Electric	

Product model/name	Manufacturer/Supplier	Specific limitation / Area of use
Delta Active Power Filter	NHP Electrical Products (NZ) Ltd.	
ABB PFQI Series	ABB/Hitachi Energy	
<b>Intrinsic Safety Barriers/Isolators</b>		
Endress & Hauser	EMC	
MTL5500 series	Carrel Electrade	
Pepperl+Fuchs	Custom Controls	
<b>Lamp Colours</b>		
White = Running	Schneider Electric / NHP / ABB	
Amber = Alarms	Schneider Electric / NHP / ABB	
White = Auto Available / General indication	Schneider Electric / NHP / ABB	
<b>Lamp indicators</b>		
Harmony 22mm, LED, 24 VDC	Schneider Electric	
Sprecher + Schuh D7 series, 22mm, LED, 24VDC or Allen Bradley 800F series, LED, 24VDC	NHP Electrical Products (NZ) Ltd.	
ABB Compact pilot light series, 22mm, LED, 24VDC	ABB	
<b>Loop Isolators</b>		
Carrel Electrade T-CDL series	Carrel Electrade	
Intech XI series	Intech	
<b>Mains fail / Phase failure relay</b>		
Carrel Electrade RP33-1-415	Carrel Electrade	
Harmony Control Relay RM22TR33	Schneider Electric	
Carlo Gavazzi DUB-01-C-M48	NHP Electrical Products (NZ) Ltd.	
IE-3100-18T2C-E		
Moxa EDS-510E-3GTXSFP	Moxa (ECS)	
<b>Overload units "DOL start"</b>		

<b>Product model/name</b>	<b>Manufacturer/Supplier</b>	<b>Specific limitation / Area of use</b>
TeSys Deca LRD, T, Giga, GV2, GV3, GV4	Schneider Electric	
Allen Bradley 193/592 series or Sprecher + Schuh CEP7 series	NHP Electrical Products (NZ) Ltd.	
ABB T/TF/TA series	ABB	
<b>Power factor correction (static)</b>		
Schneider VarPlus Can series	Schneider Electric	
Frako LKT series	Frako	
Circutor OPTIM range, CLZ-HD. Includes Max P&OP and SMART III	LPI NZ	
<b>Power factor correction (active)</b>		
Sinexcel Static Var generator	Power Electronics	
Delta Static Var Generator	NHP Electrical Products (NZ) Ltd.	Delta Static Var Generator
ABB PFQI Series	ABB/Hitachi Energy	ABB PFQI Series
EVC + PFV	Schneider Electric	EVC + PFV
<b>Power quality meters</b>		
Socomec DIRIS A40	Dataguard NZ	
Schneider PM5000 series Schneider PM8000 series	Schneider Electric	
IME – NEMO96 or Carlo Gavazzi W40/W50	NHP Electrical Products (NZ) Ltd.	
<b>Power Supply - ELV DC Battery Backed</b>		
Helios - SR series No Break – Series with Battery Condition Testing	Helios Power Solutions	
Phoenix Contact – QUINT UPS-IQ Power Supply series	Phoenix Contact Ltd.	
Easy UPS 24Vdc (Requires external 24Vdc power supply or source).	Schneider Electric	
Allen Bradley 1606-XLS240-UPS	NHP Electrical Products (NZ) Ltd.	
PB256-series PB251A /DC UPS	Powerbox	
<b>Power Supply - ELV DC Non-Battery Backed</b>		

Product model/name	Manufacturer/Supplier	Specific limitation / Area of use
Allen Bradley 1606 series	NHP Electrical Products (NZ) Ltd.	
Helios – SR series	Helios Power Solutions	
Phoenix Contact – QUINT-PS series	Phoenix Contact Ltd	
Schneider Phaseo Series	Schneider Electric	
Puls slim power supply. C-series	Puls	
<b>Power Supply – DC-DC converters</b>		
RF Industries model UNITEK SDC08	RF Industries	
Helios Power Solutions - IEXT/IEHT series	Helios Power Solutions	
Phoenix Contact – QUINT DC/DC converter series	Phoenix Contact Ltd.	
Modicon power supplies	Schneider Electric	
Allen Bradley 1606 XLD series	NHP Electrical Products (NZ) Ltd.	
<b>Programmable logic controller (PLC)/ Remote terminal unit (RTU)</b>		
Area dependant, refer to Watercare for requirements		
<b>Push Buttons</b>		
Harmony XB4 and, XB5, XAL 22mm (230 VAC push buttons to be fitted with terminal,	Schneider Electric	
Sprecher + Schuh D7 series, 22mm (230 VAC push buttons to be fitted with terminal, shrouds)	NHP Electrical Products (NZ) Ltd.	
ABB pushbutton series, 22mm (230 VAC push buttons to be fitted with terminal, shrouds)	ABB	
Teltonika TRB 256 Wireless Gateway	Go Wireless PB Tech	
<b>Relays 230VAC Coil</b>		
Omron MY series	Electrical Wholesalers (refer: Procurement)	
Zelio RXM series	Schneider Electric	

Product model/name	Manufacturer/Supplier	Specific limitation / Area of use
ABB CR-M series	ABB	
Allen Bradley 700 series	NHP Electrical Products (NZ) Ltd.	
<b>Relays 24VDC Coil</b>		
Omron MK series	Electrical Wholesalers (refer: Procurement)	
Harmony RUM series	Schneider Electric	
ABB CR-U series	ABB	
Allen Bradley 700 series	NHP Electrical Products (NZ) Ltd.	
<b>Relay (Safety) e-stop</b>		
Allen Bradley Guardmaster 440R	NHP Electrical Products (NZ) Ltd.	
Harmony Preventa XPS Universal	Schneider Electric	
Type S4 for Direct on line	PILZ	
Type S5 for VSD	PILZ	
<b>Rotary Switches</b>		
Kraus & Naimer Blue Line	Electrical Wholesalers (refer: Procurement)	
Telemecanique Cam Switches series	Schneider Electric	
Sprecher + Schuh L2 series	NHP Electrical Products (NZ) Ltd	
<b>Security Systems</b>		
Gallagher 6000 system	Advance Security Ltd	
<b>Soft starters</b>		
Altistart series	Schneider Electric	
Allen Bradley SMC series	NHP Electrical Products (NZ) Ltd	
ABB – PSE	ABB	
V5 series	Power electronics	
<b>Surge Protection</b>		
ERICO EDT2 series	Helios Power Solutions	
Acti 9 – PRD & iPRF series	Schneider Electric	

Product model/name	Manufacturer/Supplier	Specific limitation / Area of use
Cirprotec series	NHP Electrical Products (NZ) Ltd.	
ABB OVR PV series	ABB	
VAL-SEC-T2-3S-350-FM VAL-SEC-T2-3C-350-FM	Phoenix	
V20 with FS	OBO Bettermann, MARDAG	Remote signalling required
<b>Switch – 3 Position (Auto/Off/Manual)</b>		
Kraus & Naimer Blue Line	Electrical Wholesalers	
Telemecanique Harmony Style 4, 22mm Harmony Series 22mm	Schneider Electric	
Sprecher + Schuh D7 series, 22mm or Allen Bradley 800F series	NHP Electrical Products (NZ) Ltd	
ABB Compact pilot light series, 22mm	ABB	
<b>Terminal Rail</b>		
DIN Rail	Electrical Wholesalers	
<b>Terminals – feed through</b>		
Linergy TR (screw type)	Schneider Electric	Linergy TR (screw type)
Allen Bradley 1492 series (screw type)	NHP Electrical Products (NZ) Ltd	Allen Bradley 1492 series (screw type)
Klippon SAK (screw type) 2.5mm or as appropriate for larger cables.	Electrical Wholesalers	Klippon SAK (screw type) 2.5mm or as appropriate for larger cables.
Phoenix Contact (screw type) 2.5mm or as appropriate for larger cables.	Electrical Wholesalers	Phoenix Contact (screw type) 2.5mm or as appropriate for larger cables.
Conta-Clip SRK/RK	Mardag Holdings	Conta-Clip SRK/RK
<b>Terminals – Fused</b>		
Klippon ASK1 fitted with appropriate 20 mm glass fuses for ELV/LV	Electrical Wholesalers	
Phoenix Contact fitted with appropriate 20 mm glass fuses for ELV/LV	Electrical Wholesalers	

<b>Product model/name</b>	<b>Manufacturer/Supplier</b>	<b>Specific limitation / Area of use</b>
Linergy TR fitted with appropriate 20 mm glass fuses for ELV/LV	Schneider Electric	
Allen Bradley 1492 series fitted with appropriate 20 mm glass fuses for ELV/LV	NHP Electrical Products (NZ) Ltd	
<b>Thermistor relays</b>		
TeSys LT3 series, & Tesys T	Schneider Electric	
Allen Bradley 817 series	NHP Electrical Products (NZ) Ltd.	
ABB CM-MS series	ABB	
<b>Timers</b>		
Omron H3 series	Electrical Wholesalers	
Schneider Zelio series	Schneider Electric	
Carlo Gavazzi series/ Allen Bradley 700 series	NHP Electrical Products (NZ) Ltd	
ABB CT series	ABB	
<b>Transducers – Voltage, Current, Temperature etc.</b>		
Carrel Electrade	Electrical Wholesalers	
<b>Trunking</b>		
Standard electrical switchboard trunking	Electrical Wholesalers	
<b>Water heater isolator</b>		
PDL 56 series	Schneider Electric	
ISO series	NHP Electrical Products (NZ) Ltd.	

## 13.13.2 Luminaires

### General requirements

- a) Comply with [section 13.13.1](#).
- b) [Luminaires and their fittings shall have minimum IP65 rating](#)
- c) Road lighting performance to AS/NZS 1158.
- d) Interior lighting for industrial tasks and processes performance to AS/NZS 1680.2.4. Where there is the likelihood of corrosive gasses present, the luminaire body shall be of die-cast aluminum with a copper content of less than 0.1%. Where corrosive gasses will not be present, polycarbonate plastic can be used with stainless steel fixing and HDG stirrups.
- e) Exterior fittings shall be vandal-resistant
- f) LED lighting to IEC/PAS 62717 or IEC/PAS 62722.

### Quality Control

- a) All products shall be marked in accordance with the conformity assessment body's requirements.
- b) Product certification (ISO Type 5) to applicable product type in accordance with the referenced standard.

### Standardised products

The following products are examples of preferred light fittings. Alternative products which are to the same or a higher specification may be used after approval is received in writing from Watercare.

Product model/name	Manufacturer/supplier	Specific limitation
LUGANO m1200 Tubular Luminaire – IP69K	Norka / Techlight	Not explosion proof and not suitable for Zone 1 hazardous areas as classified in AS/NZS 60079, Typical application: wet wells
TRILUX MIRONA FIT B LED 26000-840	MHL	High bay plant rooms (cable suspended)
TRILUX MIRONA FIT B LED 6000-840	MHL	Switchrooms (cable suspended)
PHILIPS CONDOLA LED BWG201	Philips	Small rooms e.g. air locks, toilets, etc (ceiling mounted)
PACIFIC LED 1300mm WT460C	Philips	Plant rooms (suspended)
ADLT CREE XSPW Version B Type 4M	ADLT	Plant rooms, stairwells (wall mounted)
BETACOM SCHREDER PIANO GEN2	BETACOM SCHREDER	Road lighting (pole mounted)
2X10W LED EMERGENCY SPOTLIGHTS	Legrand	Plant rooms, switchrooms, walkways etc.
LED SATELLITE 2W	Legrand	Plant rooms, switchrooms, walkways etc.
WEATHERPROOF EXIT SIGNS - 2X1W ILLUMINATED	Legrand	Plant rooms, switchrooms, walkways etc.

**Procurement schedule**

Alternative products may be acceptable if equivalent or superior in specification to those listed in the 'Standardised Products' table above. All fittings to be procured shall be identified in a procurement schedule (example below) and submitted to Watercare for approval with data sheets.

Minimum standard required	Design specific requirements	Supplier submission
Description of application		
Lighting performance – lumens		
Luminaire type		
Product and Test certificates		

### 13.13.3 Socket outlets

#### General requirements

- a) Comply with [section 13.13.1](#).
- b) Manufacturing standard to AS/NZS 3112.
- c) IP56 rated.
- d) 15 Amp.
- e) All general purpose three phase socket outlets shall be 4C+E i.e. must have a neutral.
- f) Outdoor general purpose power enclosure distribution shall be:
  - Wall mounted
  - Minimum IP56
  - Fastening with stainless steel fixtures
  - Contain switchable unit isolator
  - All circuits protected by RCD.
  - Unit protected by over current and short circuit protection
  - Installed as per manufacturer's instructions.

*Exception: Sockets located in office areas shall be standard 3-pin 10A white polycarbonate, flush mount*

#### Quality Control

- a) All products shall be marked in accordance with the conformity assessment body's requirements.
- b) Product certification (ISO Type 5) to AS/NZS 3112.

#### Procurement schedule

Minimum standard required	Design specific requirements	Supplier submission
Description of application		
Outlet phases		
Product and Test certificates		

#### Standardised products

Product model/name	Manufacturer/supplier	Specific limitation
<b>Power outlets (Single phase)</b>		
PDL 56 series	Schneider Electric	
ISO series	NHP Electrical Products (NZ) Ltd.	
Lifeguard	Jackson Industries	
<b>Power outlets (Three phase)</b>		
PDL 56 series	Schneider Electric	
ISO series	NHP Electrical Products (NZ) Ltd.	ISO series

Lifeguard	Jackson Industries	
<b>Power outlets (Single phase-switchboard control cubicle)</b>		
PDL 600 series (RCD protected)	Electrical Wholesalers	

### 13.13.4 Switchboards

#### General requirements

- a) All switchboards shall comply with [section 13.13.1](#).
- b) [Switchboards are as defined in AS/NZS 3000](#).
- c) [A complete set of drawings must be provided for mechanical and electrical construction in accordance with Watercare's Standard for producing CAD and geospatial drawings \(ESF-500-STD-502\). Preference is that Watercare's drawings are not duplicated by the manufacturer but shall instead be 'As Built' on completion of construction. Documents expected to be submitted for approval shall include the following as a minimum:](#)
  - [Single line diagrams \(WSL drawing preferred\)](#)
  - [Three-line diagrams \(where deemed necessary\)](#)
  - [Schematics \(WSL drawings preferred\)](#)
  - [General arrangements \(internal, external, front, section etc.\)](#)
  - [Labelling diagrams](#)
  - Equipment schedules
- d) All switchboards shall be manufactured to the latest version of AS/NZS 61439 form 4a. The only exceptions are the following:
  - Switchboards may be constructed to AS/NZS 61439 Form 2 and 3 but only if explicitly approved in writing by Watercare.
  - Small, simple, standalone (i.e. separate from a main switchboard), wall mounted switchboards, rated not more than 100Amps i.e. lighting and small power DBs or process DBs, may be constructed to AS/NZS 61439 Form 2.
- e) The switchboard shall allow for future addition of vertical sections.
- f) Removable end plates shall be provided to cover the horizontal power bus and horizontal wire way openings on each end of the switchboard.
- g) Wire ways shall be provided to allow cable access into each cell.
- h) No terminations shall be located in the wire way(s), except for neutral and earth connection bars.
- i) All switchboard equipment, wiring and components, nuts and bolts, shall be accessible from the front. Bus bars shall be accessible from the back unless otherwise specified.
- j) Allowance shall be made for design specified ventilation and heat dissipation.
- k) The switchboards shall be formed of corrosion resistant sheet metal to give a uniform appearance with no sharp corners, buckling or distortion.
- l) Framing, panels and sections screwed or bolted together using machine threaded fixings.
- m) Nuts and bolts shall be cadmium-plated, stainless steel or nylon as appropriate for the specified operating environment.
- n) The switchboard shall be supplied with a hot dipped galvanised plinth, which shall be manufactured from parallel flange mild steel channel 100 x 50, drilled front to back, with four 51mm diameter lifting holes. All lifting and fixing holes shall be pre-drilled prior to galvanising.
- o) Access to all cells and wire ways shall be via hinged vertically mounted lockable doors. Minimum door swing shall be 120°. Switchboard doors shall be individually earth bonded to the switchboard frame with insulated flexible copper braid. Earth bonding through the door hinges only is not acceptable.
- p) A minimum of two hinges shall be used for each panel or door. Where a panel or door is 1200 mm high or greater, a minimum of three hinges shall be used.
- q) The doors for all switchboards located in access controlled switchrooms shall be lockable as follows:
  - Through the use of a lock that requires a tool to open it e.g. quarter turn triangle, square, double bit or slotted.
  - Through the use of a key. If a key is suited it shall be:
    - Lock barrel -Type CLF85-144 (16 mm barrel length)

- Key: No. 144 (the standard electrical industry key number)
  - The lock unit shall be fitted at mid-height
  - Outdoor switchboards shall be key access only. The key access requirement shall be confirmed with Watercare
- r) Additional latches or closers are to be operable without the use of a tool or key.
- s) In the case of double doors, 900 mm high or greater, a three-point engagement mechanism shall be operated by the handle being turned through 90 degrees. The three engagement points are to be located at the top, the centre and the bottom of the panel or door.
- t) The switchboard colour shall be as follows unless otherwise approved:
  - External surfaces – RAL 7032, RAL 7035 or Oxyplast Almond
  - Interior gear plates – Gloss white
- u) Refer to the electrical design standard for minimum seismic resilience requirements.

**Switchboard electrical requirements:**

- a) Busbars shall be of high-grade copper and carry a standards mark.
- b) Busbars shall be treated against the corrosive effects of hydrogen sulphide and sulphur dioxide by means of electrolytic tinning. The busbars shall be naturally cooled and be identified heat resistant appropriately coloured PVC sleeves (red, white, blue etc.).
- c) The neutral busbar shall be the same cross-sectional area as the phase busbars.
- d) The busbars shall be of uniform cross section throughout their vertical or horizontal run. Tapered busbars are not acceptable.
- e) A tinned bare copper earth (BCE) bar rated for the short circuit duty of the switchboard shall run throughout the length of the board. All non-current carrying metal parts shall be earthed by connecting to this bar
- f) A BCE with a minimum size of 5x35mm shall be installed vertically in each wire way and pre-drilled with suitable holes.
- g) Main horizontal busbars and vertical droppers shall be enclosed in a separate compartment with screwed covers or doors. The connection to droppers shall be through the insulating barriers.
- h) Openings for future busbar extension and panel wiring shall be provided at both ends
- i) The switchboard main earth and neutral connection points shall be easily accessible to allow for testing after installation.
- j) All main switchboards shall be fitted with a suitably sized marked MEN link installed in an easily accessible position.
- k) A 36-way 63A brass tunnel bar is to be fitted to allow easy connection of the instrument earth wires (mounted in the control cubicle section).
- l) Exposed terminals for voltages above extra low voltage shall be IP2X via manufacture or transparent, colourless shrouding (i.e. all 110/230/415 Vac connections). The switchboard shall be arranged so that no live conductors are exposed under conditions of maintenance. All phase conductor busbars that are accessible via a door shall be fitted with easily removable transparent, colourless shrouding to protect against accidental contact by personnel. The intention of this clause is to provide accidental touch protection during fault finding.
- m) Provision shall be made to adequately support all incoming and outgoing cables against mechanical stress.
- n) Removable split aluminium gland plates (minimum thickness 5mm) shall be provided at each switchboard cable entry point. PVC gland plates are not acceptable.
- o) The main incoming section and larger motor cable wire ways will require a 6mm aluminium gland plate. The mounting frame shall be rigid enough to prevent deflection of the gland plate.
- p) A wire way shall be supplied to allow cable access into each cell. Only Earth and Neutral connections shall take place in the wire way.

- q) A neutral connection point shall be fitted in each wire way (sized at 0.5 times the rated current of the main busbars). The connection point shall allow easy conversion to a full neutral bar if required by Watercare.
- r) Switchboard cell main isolators shall be mechanically interlocked such that the switchboard cell door cannot normally be opened when the isolator is in the 'on' position. It shall be possible to defeat the interlock and open the door with the isolator on, only with the use of a special tool and only when the isolator is not padlocked off.
- s) All switchboard cell main isolators / circuit breakers shall be of the extended handle, rotary type and lockable in the off position with a padlock. They shall be capable of interrupting the full prospective short circuit current of the board at rated voltage and frequency. Circuit breaker co-ordination shall be Type 2.
- t) Any isolator / switch rated above 63A shall not be mounted on the switchboard door. Any wiring looms connected to the cubicle doors shall have a gooseneck and sufficient slack to allow the doors to open easily and fully without placing any undue strain on the wiring.
- u) A wire way shall be provided across the top of the switchboard to allow the interconnection of cables between cells.
- v) Power and CT secondary wiring shall have a minimum cross-sectional area of 2.5mm<sup>2</sup> and be of stranded flexible copper high temperature PVC panel wire, unless otherwise specified. Matching terminals and shorting links shall be provided for all CT secondary circuits.
- w) Control wiring shall be stranded flexible copper high temperature PVC panel wire of minimum 0.75 mm<sup>2</sup> matching the current requirement.
- x) Control wiring connected to the DCS/PLC I/O module terminations shall be minimum 0.5mm<sup>2</sup>. The wiring must be terminated in rail mounted terminal blocks mounted in the same cubicle.
- y) Within cubicles, control and power wiring shall be enclosed in separate slotted PVC ducting. Cable ducting shall be sized for a minimum of 50% spare capacity. Wiring not enclosed in ducts shall be loomed together neatly. Cable ties at 150mm centres shall be used. For looming, adhesive tape is not acceptable.
- z) The distance between cable ducting and equipment shall be minimum 35mm to allow wire termination.
- aa) Refer to Watercare's Electrical Construction Standard (ESF-600-STD-703), Section 2.12 for labelling, colour coding and identification.
- bb) Equipment shall be identified in accordance with the labels on the design drawings. All major fixed components within the switchboard including switches, relays and circuit breakers shall be labelled.
- cc) Indicator lamps shall be high intensity LED type. Refer to Watercare's Electrical Construction Standard (ESF-600-STD-703), Section 2.12 for push buttons and lamp indication colours.
- dd) Both ends of each wire shall be identified with a Grafoplast system of ferrules, crimp pins and markers.
- ee) Switchboards shall be provided with labels detailing the following information (Refer Section 2.12 of Watercare's Electrical Construction Standard: ESF-600-STD-703):
  - Plant asset number (tag name)
  - Manufacturer's name
  - Switchboard's form factor, serial number and the year of manufacture
  - Applicable standards
  - Degree of protection
  - Rated operating voltage
  - Rated frequency
  - Main busbar continuous current rating
  - Main busbar short circuit capacity
- ff) Equipment in the switchboard other than door mounted control switches, indicators and meters shall be mounted on removable gear plates fixed to the frame of the switchboard. Wherever possible equipment shall be DIN rail mounted on the gear plate.

- gg) DC power supplies and batteries shall be mounted in the PLC control cubicle. Batteries shall be mounted with seismic restraints. The mounting shall also allow easy removal and checking of the batteries while still connected to the supply.
- hh) One 60Watt heater shall be fitted at the bottom of each wire way controlled via a thermostat situated as close as practical to the top of that wire way. The thermostat shall be located in a position that will not impede cable installation. Wire way heaters are not required for switchboards located within temperature controlled switchrooms.
- ii) Main switchboards with an incoming isolator greater than 80A shall have a power meter equipped with a Modbus RTU (via RS485) or a Modbus TCP Interface.
- jj) The main switchboard shall have 3 phase surge protection installed. This shall comprise a surge diverter which complies with ANSI/IEEE C62.41.2 Cat A, Cat B, Cat C standards.
- kk) The Switchboard shall have an internal arc withstand as per the rating defined on the single line drawing. All switchboards with a rating  $\geq 800$ Amps shall have increased security against the occurrence for the effects of internal arcing faults in compliance with AS/NZS 61439.1, Appendix ZC. The switchboard shall be type tested in accordance with IEC TR 61641.

#### **Generator connections for indoor switchboards**

- a) The generator connection enclosure shall be mounted external to the switchroom. The location shall be adjacent to the permanent generator/temporary generator laydown area.
- b) The generator connection enclosure shall be IP66 rated, 316 stainless steel with a lockable hinged panel at the bottom for the generator cable entry, refer to standard enclosure drawings.
- c) A split rubber barrier shall be fitted over the generator cable entry point to provide touch protection.
- d) Connection stabs for the three-phases, neutral and earth shall be provided in the generator connection enclosure.
- e) Cabling shall be provided to connect the generator connection to the main switchboard generator circuit breaker or changeover switch.
- f) A mechanical interlock shall be provided between the main incomer and changeover switch.
- g) A suitable generator cable entry point into buildings must be approved by a suitably qualified civil engineer.

#### **Outdoor switchboards**

- a) Outdoor switchboards shall be housed in a pillar box arrangement constructed of powder coated marine grade aluminium (colour = BS 5252 weight and group colour "12 - B29") or 316 stainless-steel.
- b) All doors shall have wind stays to keep the door(s) in a fixed position when open.
- c) A flush mounted lock shall be provided keyed to Watercare requirements.
- d) The pillar box shall include a pedestal for mounting the switchboard and a gland plate to separate the switchboard from the pedestal. All cables shall enter the pillar box from the bottom.
- e) IP ratings for this equipment are as follows:
  - Switchboards not requiring vents for equipment cooling shall have a minimum IP65 rating.
  - Switchboards requiring vents for equipment cooling shall have a minimum IP55 rating.

#### **Quality Control**

- a) All products shall be marked in accordance with the conformity assessment body's requirements.
- b) Product certification (ISO Type 5) to AS/NZS 61439.

#### **Procurement schedule**

Minimum standard required	Design specific requirements	Supplier submission
Manufacturers name		
Country and city of manufacture		
Source & country of source of principal switchboard components		
Fully compliant with referenced standards		
Main busbar rating (rated current) – Ampere		
Main busbar rating (short-time withstand current) - kA		
Distribution busbars (rated current) – Ampere		
Distribution busbar rating (short-time withstand current) – kA		
Design verification – Testing OR calculation/measurement OR application of design rules		
Form rating (to AS61439.1)		
Copies of Certificates of Compliance Included		
Maximum temperature rise of busbars above ambient		
Metalwork gauge (mm)		
Ventilation/heat dissipation requirements		
Paint Finish		
Colour (External)		
Colour (Internal)		

**Standardised products**

Product model/name	Manufacturer/supplier	Specific limitation
Cubic modular system	Cubic / NHP Accredited Cubic assemblers	Up to the Type Tested current limit of the switchboard

Logstrup	LECO Sales	Up to the Type Tested current limit of the switchboard
Powerak	MGE	Up to the Type Tested current limit of the switchboard
250 Series Axiom System	BREMCA	Up to the Type Tested current limit of the switchboard

### 13.13.5 Control panel manufacture and supply

#### General requirements

- a) A control panel is defined as any enclosure (other than a switchboard, field control station, or junction box) housing electrical devices (PLC, DCS, RTU, relays, switches etc.) for the control of equipment.
- b) The control panels (DCS, PLC, RTU, etc.) may be integrated with switchboards or be stand-alone panels as specified.
- c) The manufacturer shall supply a complete set of drawings, operation and maintenance manuals and a list of recommended spare parts.
- d) Separate protective, instrument and isolated earthing systems shall be provided in each control panel as per the controller manufacturer's explicit requirements. General guidance is as follows:
  - a. DCS panels shall comply with the DeltaV Power and Grounding guidelines:
  - b. PLC/RTU panels shall have two types of Earth as follows:
    - i. Instrument Earth for instrumentation, screens, etc.
    - ii. Protective Earth for all other earthing e.g. panel body, equipment protection. The Instrument Earth shall be connected to the PLC panel independently from the Protective Earth and shall have its own main terminal and distribution terminals rail.
- e) Where required, the instrument earth shall be directly bonded to the main earth bar with a minimum 35mm<sup>2</sup> copper earth conductor.
- f) Factory acceptance testing shall include but not be limited to:
- g) Confirmation that all panels are complete, e.g. metalwork, electrical wiring, equipment installation.
- h) Check wire labelling and equipment tagging is correct.
- i) Check electrical equipment for conformance to specifications
- j) Check that all indicators have been installed.
- k) Check for satisfactory operation and freedom from defects for all mechanical features e.g. doors, latches and hinges.
- l) Check finish is free from defects, including miscellaneous filler plates and panels.
- m) Check the proper size, specification, installation and operation of the 24Vdc power supply unit.
- n) All testing has been completed and documented e.g. visual inspection, continuity, insulation resistance (if applicable).
- o) Perform a functional test of each item of equipment, including relays, timers, indicators switches, pushbuttons and solenoids.
- p) Factory acceptance test reports shall be submitted to Watercare for approval prior to shipment to site.

#### Construction

- a) The control panels shall be vertically oriented, general purpose IP55 rated enclosures, wall mounted or free standing for floor mounting. A lower IP rating will only be acceptable with written approval from Watercare.
- b) The control panels shall have hinged doors, full height rear mounted gear plates, gland plates, terminations and trunking as shown on the design drawings.
- c) The control panels shall be supplied complete with a corrosion protection coating system. The panel colour shall be RAL7035.
- d) Panels shall be supplied complete with 75mm high base mounting channel and all fixing bolts, anchors, nuts washers, gaskets, vibration mountings and any other fastenings necessary for the complete installation of the panel.
- e) Panels shall be front access unless otherwise specified.

#### 13.13.5.1 Heat dissipation

**Heat loading (both internal and ambient) shall be accommodated in the design, and heat rejection shall accommodate full load operation at the stated ambient temperature. The heat dissipation shall be in accordance with AS/NZS 61439 and component manufacturer specifications. Calculations shall be provided with the design for approval.**

- a) Where fan cooling/pressurising of the control panel is provided, filtering of the air shall be included. The fan/filter shall not degrade the IP rating of the panel.
- b) Heat dissipation calculations shall be provided to Watercare for approval.
- c) Purafil filters shall be fitted to panels where gases such as methane and hydrogen sulphide may be present. The Purafil filters are to clean the air entering the panel when the panel door is closed.

#### **Cable entry and supports**

- a) Top entry is preferred for indoor control panels in dry areas. Bottom cable entry is required for outdoor control panels or those located in damp areas. The supplier shall provide a minimum of two non-magnetic, undrilled gland plates, bolted in position, per panel, for cable entry.
- b) Field instrument cable cores and switchboard conduit wires shall terminate at marshalling section terminal blocks within the control panel. Panel wiring shall connect marshalling section terminal blocks to M Series DCS, S series DCS and PLC I/O cards. It is only acceptable to connect field wiring directly to DCS CHARM I/O terminal blocks.
- c) Trunking systems shall be provided for the support of incoming and outgoing cables within the control panel enclosure. Trunking shall be sized to allow for un-terminated spare incoming cores with an additional 30% spare capacity for future. The supports shall be so located that they do not obstruct terminations.

#### **Power supplier and I/O**

- a) Each DCS/PLC panel shall have (at least) two dc power supply units supplying loads via a diode-based redundancy module. More than one set of dc power supplies/redundancy modules may be needed for system requirements and redundancy.
- b) When utilizing M-series or S-series DeltaV I/O, the control panel simplex I/O terminal blocks shall be designed for use with DeltaV AI 8-channel terminal block (2 wire / 4 wire) – Part number SE4003S2B1 (as of May 2017).

#### **Radio installation requirements**

- a) A gland suitable for co-axial cable shall be installed in the control cubicle gear plate for routing the radio antenna cable to the exterior of the building.
- b) The lightning arrestor shall be installed as close as possible to the exit gland of the radio antenna cable and connected to the main earth busbar with 6mm<sup>2</sup> insulated copper PVC earth cable.

#### **Wiring and terminations**

- a) Terminal blocks for power distribution shall be compression type and shall be labelled as per the drawings.
- b) Terminal blocks shall be sectional TS35 Din Rail mounted screw type of suitable size for direct connections.
- c) Spare terminals and spare DIN rail shall be installed as per the drawings.
- d) All panel wiring, as far as practical, shall be supported in trunking. Segregation of 24 vdc / 4-20mA circuits from 240/110 Vac circuits shall be provided to prevent signal interference arising from continuous or transient coupling.

- e) Control wiring shall be tinned stranded flexible copper high temperature PVC panel wire of minimum 0.75 mm<sup>2</sup>.
- f) Power secondary wiring shall have a minimum cross-sectional area of 2.5mm<sup>2</sup> and be of tinned stranded flexible copper high temperature PVC panel wire, unless otherwise specified. Matching terminals and shorting links shall be provided for all CT secondary circuits.
- g) Control wiring connected to any I/O module terminations shall be minimum 0.5mm<sup>2</sup>. The wiring must be terminated in rail mounted terminal blocks mounted in the same cubicle.
- h) All terminals shall be numbered and trunking provided on both sides of the terminals. The trunking shall be grey slotted PVC, with a minimum of 20% spare capacity.
- i) The distance between cable ducting and equipment shall be minimum 35mm to allow wire termination.
- j) No more than two conductors shall be terminated both sides of each terminal. Wire termination shall be with suitable ferrules or crimp lugs. Soldered connections are not permitted.
- k) Termination on devices shall be shrouded to prevent contact with live parts
- l) Terminal blocks shall be DIN rail mounted with supports and identification accessories. The termination blocks shall allow the following:
  - m) Testing of circuits connected to the terminal
  - n) Linking of adjacent terminals
  - o) Screw-clamp type connections
  - p) Cross-linking facilities where terminals are associated with current transformers. This facility shall allow the current transformer to be short-circuited
  - q) Isolation functionality where the terminals are associated with voltage monitoring circuits
  - r) Segregation barriers between extra low voltage and low voltage terminals
  - s) The enclosure shall have 20% spare terminals for future use.
- t) All unused terminals of equipment shall be wired to the terminal blocks for spare use and labelled individually as spare.
- u) Refer to Watercare’s Electrical Construction Standard (ESF-600-STD-703), Section 2.12 for labelling, colour coding and identification.

**Identification**

- a) Ferrules shall be arranged to read left to right irrespective of side of entry to the vertical terminal strip. For horizontal terminal strip the ferruling shall be rotated 90 degrees anti-clockwise.
- b) Each end of each wire shall be tagged using a proprietary wire marking system. The wire numbers shall be as detailed on the drawings, and:
- c) All wires shall have a unique number except that where “looping” between multiple terminals, (e.g. for power supplies and grounding) multiple wires shall carry the same number when they are effectively the same wire
- d) In all cases the wire number shall be the same at both ends of a wire
- e) All wires shall be fitted with crimp pins before terminating
- f) Each device shall be identified with a white traffolyte (three layer laminated) nameplate engraved with 5mm high black text of uniform size and affixed below the respective device.

**Procurement schedule**

Minimum standard required	Design specific requirements	Supplier submission
Overall dimensions		
Internal and external protection coatings		

Minimum standard required	Design specific requirements	Supplier submission
Heat dissipation capacity within limits of AS/NZS 61439		
Internal layout drawing set		
Mounting and anchor details		
Total weight		
Air scrubber requirements		

**Standardised products**

Product model/name	Manufacturer/supplier	Specific limitation
Cubic modular system	Cubic / MGE	
Logstrup	LECO	
Rittal	Rittal	
DeltaV CTO (Configure to Order) DCS Cabinets	Emerson Process Management	
BREMCA	BREMCA	

### 13.13.6 Electric actuators

#### General requirements

- a) Comply with [section 13.13.1](#).
- b) Electrical enclosures are to be double sealed and be IP68 rated.
- c) The terminations compartment is to be sealed from the internal electrical elements with IP68 rating.
- d) Power supplies are typically 24 V dc for the motor and the control circuits on remote sites such as line-valve chambers. Established facilities or where provision is made for back-up power generation 3-phase for the motor and 24 V dc for the control circuit shall be considered.
- e) Hardwired I/O shall be used for all control and position feedback. Communications can only be used for additional monitoring functions.
- f) Rotary selector or push buttons to Open, Close and Stop when in Local Control.
- g) One three-position lockable selector for the following functions: Local, Off, and Remote.
- h) Local continuous indication of the valve position in percentage open, readily visible when the actuator is installed.
- i) Remote controls are to be at 24 V dc. These are to be activated when the local selector is in the Remote position.
- j) Remote indication via a proprietary remote display unit.
- k) Monitor relays (Normally open voltage free contacts). The relays shall be configurable to provide indication of at least the following:
  - Loss of power
  - Actuator battery low
  - Selector switch in Local or Off
  - Motor thermostat tripped
- l) Four independently adjustable limit switches are to be fitted for additional position indication.
- m) End of travel limit switches, one open and one closed limit switch, may be fitted and used to control the limits of the valve travel.
- n) Valve running indication.
- o) Valve travel limitation may use 'torque off' against its own mechanical stops to provide end of travel limit.
- p) The configuration of travel limits, torque levels, and indication contacts shall be by means of a non-intrusive handheld device or an infrared serial link to a computer.
- q) Provision for software uploading and downloading of configuration parameters is desirable (via a serial communications link).
- r) Electric actuator shall be equipped with a Modbus RTU (via RS485) or Modbus TCP Interface

#### Quality Control

- a) All products shall be marked in accordance with the conformity assessment body's requirements.

#### Procurement schedule

Minimum standard required	Design specific requirements	Supplier submission
Application description		

Minimum standard required	Design specific requirements	Supplier submission
Enclosure – Assess environment in accordance with BS EN 60079 / AS/NZS60079		
Specify corrosion protection to suit operating environment		
<b>Input flange – ISO 5211</b>		
Flange / shaft cathodic isolation		
<i>Valve type:</i> Part turn; Multi-turn		
<i>Duty cycle:</i> Isolating; Regulating; Modulating		
Operating time/turns		
Seating torque (Nm)		
Running torque (Nm)		
Thrust (kN) – multi-turn only		
Power supply to motor 24 Vdc, single phase or 3-phase		
Control circuit power supply 24 V dc		
Local indication		
Monitoring and Control via Modbus RTU (via RS485) and/or Modbus TCP		
<i>Remote indication:</i> Position; Faults		
Product and Test certificates		

**Accepted products**

Product model/name	Image	Manufacturer/supplier	Specific limitation
IQ range		Rotork	Specific to function



<p>Multi-turn</p>		<p>Auma / CSE-W. Arthur Fisher Ltd</p>	<p>Specific to function. 4 position switches required (standard supply only 2)</p>
-------------------	---	--	--

### 13.13.7 Uninterruptable power supply (UPS)

#### General requirements

- a) Comply with [section 13.13.1](#).
- b) Performance shall comply with IEEE 446.

#### Quality Control

- a) All products shall be marked in accordance with the conformity assessment body's requirements.
- b) Product test certification to AS / IEC 62040.3.

#### Procurement schedule

Minimum standard required	Design specific requirements	Supplier submission
Input rated voltage		
Input Voltage tolerance		
Input Rated frequency		
Power factor		
Output voltage		
Output voltage tolerance		
Output Rated frequency and tolerance		
Overload		
Crest factor		
Bypass rated voltage		
Bypass voltage tolerance		
Bypass rated frequency and tolerance		
Efficiency		
Operating ambient temperature		
Relative humidity range		
Operating altitude		

Minimum standard required	Design specific requirements	Supplier submission
Product and Test certificates		
Relay output for alarming		
Communications interface		

### 13.13.7.1 Standardised products

Product model/name	Manufacturer/supplier	Specific limitation
Socomec Masterys GP4	Dataguard	Preferred
Socomec Modulys XS	Dataguard	Where minimum size or space limitations preclude the use of the Masterys GP4
PB251A (12CM, 12CM-H, 24CM, 24CM-H)	Powerbox	
PB256-series (1210CML, 2405CML)	Powerbox	

## 13.13.8 Motors

### General requirements

- a) Comply with [section 13.13.1](#).
- b) Manufacturing standard to AS1359 or BS EN (IEC) 60034.
- c) Motors shall be total enclosed fan cooled (TEFC) and metric frame design.
- d) Cooling fans shall be bi-directional type. Plastic fans are not acceptable.
- e) Motor winding insulation shall comply with BS EN 60085 and be class F to this standard.
- f) Windings shall have terminations to BS4999-145. The termination box shall be 360° rotatable.
- g) The motor shall be capable of operating at full rating under reverse rotation (reversing two motor leads).
- h) Motors larger than 5.5kW or used in variable speed applications shall be protected against excessive temperature with protectors terminated in the terminal box.
- i) For motors over 11kW, temperature sensing shall be positive temperature coefficient thermistor type, to BS EN 60034-11, Class I with Class B temperature rise tripping function. Motors over 150 kW shall have embedded in the stator windings per phase and per bearing, platinum RTD, type PT100.
- j) Motor bearings shall be packed with lithium-based grease to the following requirements:
  - Bearings shall comply with ISO 281
  - Vertical shafts shall have thrust end guide bearings
  - Motors less than 11kW shall have sealed bearings and be re-greasable on larger motors
  - Bearing life shall be minimum 20,000 hours
  - VSD applications fitted with frame size IEC 315 (IEC 60072) and over shall have insulated bearings

- Temperature detectors shall be spring loaded screw type and touching the outer race. The temperature detectors shall match the thermal limitations of the motor's electrical installation
- k) Motors selected for VSD applications shall be capable of operation when supplied from a thyristor, transistor or IGBT type VSD (i.e. comply with either NEMA MG1 part 31 or IEC 60034-25). The speed range shall be 10-100 Hz. The de-rating factors shall be supplied.
- l) Motors shall be rated for 1.15 continuous service factor.
- m) Motors over 10kW shall be fitted with an anti-condensation heater, single phase 230Vac, 50 Hz to maintain the motor temperature at 6°C over the ambient temperature. VSD anti-condensation heating (dc injection) shall not be used in place of heaters.
- n) Heaters shall be wired to a separate terminal block within the motor terminal box. Motor heaters shall be powered via a miniature circuit breaker or fuse connected to the load side of the motor isolator/breaker.
- o) Anti-condensation heaters shall operate continuously whenever the motor is at standstill.
- p) Motors shall have provision for earthing in accordance with BS EN 60034 and shall be provided with a machined boss, tapped for a bolt of suitable size, for earthing purposes.
- q) The maximum permitted noise emission level shall not exceed 80 dB.
- r) Motor connection shafts shall be keyed.

### **Motor performance ratings**

- a) Motors shall be rated to a minimum of IP55. Submersible motors shall be IP68 rated.
- b) Motor duty shall be duty class S1 for continuous operation with up to short term overloads of 150% for 60 seconds unless otherwise specified.
- c) The driven loads power requirements shall not exceed 95% of the motor rating
- d) The electric motor shall be capable of operating continuously, at the rated torque, within the voltage limits  $\pm 6\%$  of nominal supply value and within  $\pm 2\text{Hz}$  from nominal supply frequency value.
- e) Motors shall be rated for a minimum of 15 starts per hour.
- f) The efficiency rating of motors shall be "eff1".
- g) The starting characteristics shall be in accordance with AS1359.41 Design N (normal torque, three phase, cage induction motors, intended for direct online starting, having 2, 4, 6 or 8 poles and rated from 0.4 kW to 630 kW at a frequency of 50 Hz).
- h) Motors shall be able to start under full-load and accelerate smoothly to full speed.

### **Submersible motor specific requirements**

- a) The motors shall be of the 3-phase, squirrel-cage induction type, suitable for a 400Vac, 3-phase, 50Hz. supply. Duty S1 and rated for Class MCR.
- b) Provided with an integral cable(s) to specified length.
- c) The variable speed drives for borehole pumps shall have a  $dV/dt$  rate less than  $500\text{V}/\mu\text{s}$ .

### **Quality Control**

- a) All products shall be marked in accordance with the conformity assessment body's requirements.
- b) Product certification (ISO Type 5) to AS1359 or BS EN (IEC) 60034.

### **Accepted products**

Product model/name	Manufacturer/supplier	Specific limitation
ABB	ABB	Needs to meet requirements of the efficiency and usage
Brooke Crompton	Brook Crompton	Needs to meet requirements of the efficiency and usage
Flygt	Xylem	Needs to meet requirements of the efficiency and usage
GEC Alstom	Alstom	Needs to meet requirements of the efficiency and usage
KSB	KSB	Needs to meet requirements of the efficiency and usage
Sulzer	Sulzer	Needs to meet requirements of the efficiency and usage
Toshiba	Toshiba	Needs to meet requirements of the efficiency and usage
TECO	TECO	Needs to meet requirements of the efficiency and usage
Tsurumi	MacEwans	Needs to meet requirements of the efficiency and usage
WEG	TR Industries	Needs to meet requirements of the efficiency and usage

### 13.13.9 Cable and connectors

Excludes fibre optic cable. Refer to [section 13.13.10](#)

#### General requirements

- a) Comply with [section 13.13.1](#).
- b) Cable selection and installation methods shall comply with AS/NZS3008.1.2.
- c) The insulation for low voltage power cables shall be XLPE (90°C or 110°C) or PVC (75°C) and 600/1000V Grade. Other types and temperature ratings may be acceptable with approval from Watercare.
- d) Cables installed adjacent to each other must allow for appropriate deratings for operating temperature
- e) Cables of low and extra low voltage circuits enclosed in the same wiring system must be insulated for the highest voltage present.
- f) Flat TPS cable shall not be used for process installations but is permitted for building services (lighting and power) wiring.
- g) Cable connectors (terminations) shall comply with AS/NZS4325, AS/NZS1600, AS/NZS4085 and IEC61442.

#### Quality Control

- a) All products shall be marked in accordance with the conformity assessment body's requirements.
- b) Product certification (ISO Type 5) for cable to AS/NZS3008.1.2.
- c) Product certification (ISO Type 5) for cable connectors to AS/NZS4325.

**Standardised products**

Product model/name	Manufacturer/supplier	Specific limitation
<b>Cable – Coaxial</b>		
RG58 50 ohm (radio dependant)	Electrical Wholesalers (refer: Procurement)	
RG59 75 ohm (radio dependant)	Electrical Wholesalers (refer: Procurement)	
<b>Cable – Control &amp; Instrument (Digital Signals)</b>		
0.5mm <sup>2</sup> "PVC Flexible control" series	Nexans	
Triangle - 0.5mm <sup>2</sup> CF series	Triangle Cables	
Prysmian Group	Prysmian Group	
Maser Communications NZ Ltd	Maser Communications NZ Ltd	
<b>Cable – Control &amp; Instrument (Analogue Signals)</b>		
"Instrolex Cable" series	Nexans	
Triangle - RD series	Triangle Cables	
Prysmian Group	Prysmian Group	
Maser Communications NZ Ltd	Maser Communications NZ Ltd	
<b>Cable – Power</b>		
Nexans	Nexans	
Firstflex	Firstflex	
Triangle Cables	Triangle Cables	
Prysmian Group	Prysmian Group	
Maser Communications NZ Ltd	Maser Communications NZ Ltd	
<b>Cable – VSD to Motor</b>		
Varolex series	Nexans	

Product model/name	Manufacturer/supplier	Specific limitation
Firstflex - HDXCY Series	Firstflex	
Triangle Cables - EU Series	Triangle Cables	
Prysmian Group	Prysmian Group	
Maser Communications NZ Ltd	Maser Communications NZ Ltd	
<b>Cable – Elect. Core/Wire Labels</b>		
Grafoplast	Electrical Wholesalers (refer: Procurement)	

**Procurement schedule for cable terminations**

Minimum standard required	Design specific requirements	Supplier submission
Type offered (cold/Heat/premoulded)		
Rated voltage kV		
Type of lug		
Lug manufacturer		
Lug manufacturer part number		
Lug conductor diameter range (mm)		
Tail length (mm)		
Creepage distance (mm)		
Diameter over cable insulation range (mm)		
<b>33kV specific</b>		
15min dry AC voltage withstand at 2.5 U <sub>o</sub> (45kV)	No breakdown or flashover	
5min dry AC voltage withstand at 4.5 U <sub>o</sub> (81kV)	No breakdown or flashover	

Minimum standard required	Design specific requirements	Supplier submission
(Outdoor) AC voltage withstand wet at 4 U <sub>o</sub> (72kV) for 1min.	No breakdown or flashover	
15min dry AC voltage withstand at 4 U <sub>o</sub> (72kV)	No breakdown or flashover	
Partial discharge max 1.73 U <sub>o</sub> (30kV). 10pC max.		
Impulse level 170kV	No breakdown or flashover	
<b>22kV specific</b>		
15min dry AC voltage withstand at 2.5 U <sub>o</sub> (30kV)	No breakdown or flashover	
5min dry AC voltage withstand at 4.5 U <sub>o</sub> (54kV)	No breakdown or flashover	
(Outdoor) AC voltage withstand wet at 4 U <sub>o</sub> (48kV) for 1min.	No breakdown or flashover	
15min dry AC voltage withstand at 4 U <sub>o</sub> (48kV)	No breakdown or flashover	
Partial discharge max 1.73 U <sub>o</sub> (20kV). 10pC max.		
Impulse level 125kV	No breakdown or flashover	
<b>11kV specific</b>		
15min dry AC voltage withstand at 2.5 U <sub>o</sub> (15kV)	No breakdown or flashover	
5min dry AC voltage withstand at 4.5 U <sub>o</sub> (27kV)	No breakdown or flashover	
(Outdoor) AC voltage withstand wet at 4 U <sub>o</sub> (24kV) for 1min.	No breakdown or flashover	
15min dry AC voltage withstand at 4 U <sub>o</sub> (24kV)	No breakdown or flashover	
Partial discharge max 1.73 U <sub>o</sub> (10kV). 10pC max.		
Impulse level 95kV	No breakdown or flashover	

Minimum standard required	Design specific requirements	Supplier submission
<b>LV terminations specific</b>		
5min dry AC voltage withstand at 3.5kV	No breakdown or flashover	
Insulation resistance 1000MΩ		

### 13.13.10 Cable support and conduit

Excludes ducting for fibre optic cable. Refer to [section 13.13.11](#).

#### General requirements

- a) Cable support shall be heavy duty manufactured from 316 stainless steel, aluminium, galvanised steel or PVC as required for the specific installation environment.
- b) Cable ladder shall comply with NEMA 16.
- c) Cable tray shall be aluminium, galvanised steel or 316 stainless steel minimum 0.8mm thickness as appropriate for the installation environment.
- d) The minimum conduit size shall be 20mm diameter and be of PVC or MDPE. Stainless steel may only be used on approval by Watercare.
- e) Galvanised componentry shall comply with AS 1214.

#### Quality Control

- a) All products shall be marked in accordance with the conformity assessment body's requirements.
- b) Product certification (ISO Type 5) for conduits to AS/NZS 3000.
- c) Product certification (ISO Type 5) for cable ladders to NEMA 16.

#### Standardised products

Product model/name	Manufacturer/supplier	Specific limitation
<b>Cable Tray</b>		
Unistrut	Electrical Wholesalers (refer: Procurement)	
<b>Cable Ladder</b>		
Unistrut	Electrical Wholesalers (refer: Procurement)	
<b>Conduit</b>		
Heavy Duty Plastic Grey (UV Stabilised) / Orange	Electrical Wholesalers	
<b>Conduit Fasteners and Saddles</b>		
Stainless Steel Saddles with Stainless Steel Fixings	Electrical Wholesalers	

### 13.13.11 Fibre optic cable, ducting and components

#### **General requirements**

- a) Cable shall be supplied in the form of a 12 x single mode G652d Microcable, suitable for installation into a 3.5mm inside diameter Microduct – supplier specification MHT1201J.
- b) Ducting shall be comprised of 5/3.5mm Microducts formed into bundles of 2,4,7 or 12. Suitable for direct burial or installation into existing ducts or cable trays (Direct burial or Direct Install) – supplier specification MHT113C & MHT2626

#### **MTP cabling**

- Meet array connector polarity requirements of ANSI/TIA-568-C-0
- Meet polarity requirements for duplex optical fibre connectors under ANSI/TIA-568-C-0
- Have a maximum insertion loss per connector of 0.35dB
- Have end face geometry compliant with IEC PAS 61755-3-31
- Have polarity & connectors compatible with FRE-12MTPM series MTP cassettes
- Utilise round mini cable construction of 3.0mm diameter
- Comply with AS/ACIF S008, IEC 60793 and IEC 60794
- Be AFL RMxMTPFX, where x is fibre type, and the core count and length are as required

#### **Pigtails, patch leads and connectors**

- Machine polished ferrules
- All pigtails in conformance with TIA-598C colour code specification. Single colour pigtails such as white or grey are not acceptable
- All connectors which terminate SMOF shall be SC
- Compliance with ITU-T G.657.A for bend insensitive SMOF
- Through connectors shall have high tolerance ceramic alignment sleeves to ensure high inter-connect ability
- Compliance with TIA-568-C for pair cross orientation and identification
- LC/UPC duplex patch leads shall have LC duplex connectors
- All SMOF pigtails, patch cords and connectors shall comply with Telcordia standards GR-326 for Telco Grade Networks to ensure ferrule end faces meet the geometry requirements for minimum insertion loss. This should be done using interferometer end face geometry testing. Test reports shall be provided
- All connectors shall be inspected using a factory grade video inspection device. The connections shall comply with IEC 61300-3-35 and AS/NZS ISO/IEC 14763.3 for pits/chips, defects and scratches on the end face of the connector during manufacturing

#### **Fibre Optic Splice Cassettes**

- Be of flame retardant and RoHS compliant ABS plastic construction
- Include a high-density Acetyl splice comb, for double stacked splices
- Include hinge mechanisms that support stacking multiple cassettes
- Incorporate two or more columns of not less than 30mm to reverse the fibre direction and spool excess fibre
- Contain spring loaded fibre clamps with padded faces to hold fibres at any of the points of entry
- Include fibre channels that protect pigtails and fibres on both sides
- Provide two dedicated “dark” fibre storage locations for unterminated fibres, preventing unterminated fibre ends from mixing with terminated fibres

- Support mounting directly to a rack mount enclosure tray without the requirement for an additional bracket to avoid reducing the available vertical space within the enclosure
- Include a hinged lid to cover and protect splices and fibres
- Attached is the AFL document for the installation instructions for the large fusion splice cassette

### **Rack mount enclosures**

- a) Enclosures for direct burial duct and fibre:
- Double extension sliding rails
  - Method of securing the incoming fibre on the rear of the enclosure, so that the cable remains static and no pressure is put onto the fibre as the enclosure draw is engaged
  - Rear bracket capable of allowing six cable sheathes to be brought into the enclosure for termination
  - A reversible rear bracket to allow left or right cable entry
  - Modular snap in adaptor plates incorporating silk screened labelling for fibre identification
  - Provision of a method of upgrade to a rodent proof enclosure through the addition of rodent proof brackets or panels, capable of supporting termination of four cable sheathes into the enclosure
  - Rack mountable with the multi position option for forward or recessed mounting
  - Made of 1.6mm mild steel, powder coated charcoal grey.
  - Enclosure supplied fully loaded with all 24 SC pigtailed, two splice trays, and 12 SC simplex through connectors with splice protector
  - Must be fully loaded AFL FRE-1RU-MOD-SS2 Static Sliding enclosure
  - The code for this AFL enclosure is RC-1CX1ML-BB-2L
  - If only 12 cores are connected these will be stored in the bottom splice tray
  - If only 12 cores are connected the spare 12 cores of pigtailed will be plugged into adaptors in the tray and the tails will be stored in the top splice tray with spare splice protectors
  - When the next 12 cores are connected, they will be installed in the top splice tray
  - The instruction manual for installation of the Static Sliding Enclosure is attached to this document
- b) Enclosures for direct install duct and fibre:
- Double extension sliding rails
  - M-shaped bracket with four entry ports on the rear of the enclosure to allow for multiple entry directions
  - Modular snap in adaptor plates with silk screened labelling for fibre identification
  - Blanking plates installed for unused portions of the enclosure
  - Rack mountable with the multi-position option for forward or recessed mounting
  - Cable management fitted to the front of the enclosure with a protective cover
  - Enclosure supplied fully loaded with all pigtailed, splice trays, and through connectors
  - Fully loaded AFL FRE-1RU-MOD-SS2 slider enclosure
  - Enclosure should be supplied fully loaded with all 24 SC pigtailed, 2 splice trays, and 12 SC simplex through connectors and splice protector
  - The code for this AFL enclosure is RC-1CX1ML-BB-2L
- c) Enclosures for MTP installation:
- Angled left and right wings at the rear of the enclosure to allow cable entry from either side without a cable gland or other entry

- Slotted left & right rear wings to allow secure attachment of pre-terminated or MTP cables
- Modular snap in adaptor plates with silk screened labelling for fibre identification
- Blanking plates installed for any unused portion of the enclosure
- Rack mountable with the multi position option for forward or recessed mounting
- Cable management fitted to the front of the enclosure with a protective cover
- Internal fibre clips to facilitate internal management of cables
- AFL FRE-1RU-MOD-WB with C tray and protective cover for labelling

d) Enclosures for wall mounting:

- A wall mount enclosure may only be used with the prior approval of Watercare
- Two doors provided for each enclosure with a key lock
- Internal fibre clips provided for management of incoming fibres
- Is capable of supporting the fixed mounting of a splice cassette
- Is capable of supporting cable entry via the top or bottom of the enclosure
- A strain relief post provided for the termination of loose tube fibre
- Modular panel design with silk screened labelling for fibre identification
- Must be AFL FWE-MOD-XX wall enclosure with splice cassette (splice cassette can be omitted for pre-terminated or MTP applications)

e) Enclosures for DIN rail mounting:

- A DIN Rail Clip provided for mounting to an existing DIN Rail
- Rodent Proof
- Capable of supporting the fixed mounting of a splice cassette
- Capable of supporting cable entry via the top or bottom of the enclosure with a cable gland and strain relief
- Capable of supporting either modular panel design, or the doubling of its capacity via mating two enclosures together. In this case a knockout must be provided between enclosures for fibre transport
- Silk screened labelling for fibre identification
- Must be AFL FDE-xx DIN rail enclosure (where xx identifies the core count and fibre type)

f) IP rated external enclosures:

All 9 core connections to 24 fibres shall use EZ Mate connectors. All externally mounted wall mounted enclosures must:

- Be made from 316 Stainless Steel
- Be minimum IP66 rated
- Have lockable doors
- Use SCA for SMOF
- Use SC for MMOF
- Have a splice tray fitted when used for splicing
- Be AFL RITxx-SCA

***Pre-terminated harsh environment fibre optic networks***

All pre-terminated harsh environment fibre optic networks shall use pre-terminated IP rated connections to simplify fibre optic connections. All 8 core connections or less shall use expanded beam connectors, and:

- a) Be made from 316 Stainless Steel.
- b) Be MIL-DTL-83526 compliant.
- c) Be Hermaphroditic.
- d) Have an insertion loss with a maximum of 1.5db for SMOF.
- e) Have an insertion loss with a maximum of 1.0db for MMOF.
- f) Have a return loss > -32db.
- g) Have crush resistance of 6.7kN.
- h) Have cable retention of 1500N.
- i) Be capable of water immersion to at least 15 metres.
- j) Have an operating temperature range of at least -40 °C to +70 °C.
- k) Be AFL expanded beam connectors.
- l) Be hermaphroditic.
- m) Have mating durability compliant with TIA-455-21.
- n) Have impact resistance compliant with TIA-EIA-455-2.
- o) Have Cable retention compliant with TIA-455-6.
- p) Have Crush resistance compliant with TIA-455-26.
- q) Have Water immersion compliant with EIA/TIA-455-98.
- r) Must be AFL EZ Mate connectors.
- s) All pre-terminated harsh environment connectors shall be factory terminated onto milspec cable complaint to TIA/EIA-455-41, TIA/EIA-455-25 and TIA/EIA-455-104 military requirement.

### **Quality Control**

- a) All products shall be marked in accordance with the conformity assessment body's requirements.
- b) Product certification (ISO Type 5) to the referenced standard where nominated.

### **Standardised products**

<b>Product model/name</b>	<b>Manufacturer/supplier</b>	<b>Specific limitation</b>
<b>Fibre Cable - Accessories</b>		
AFL - Pigtails, Patchcords, Connectors, Large Fusion Splice Cassettes SPLCASS-LSH-HD etc.	Maser Communications (NZ) Ltd	
<b>Fibre Cable – Blown Cores</b>		
Emtelle 12 x Single Mode G652d EPFU Part No. EM-SM12F	Maser Communications (NZ) Ltd	
<b>Fibre Cable - Duct</b>		
Emtelle Direct Bury 5/3.5 Duct 2 way Part No EM-DB2-5 4 Way Part No EM-DB4-5 7 Way Part No EM-DIT7-5	Maser Communications (NZ) Ltd	

Product model/name	Manufacturer/supplier	Specific limitation
<b>Fibre Cable – Labels</b>		
TNA Industries Cable Markers	Electrical Wholesalers	

### 13.13.12 Variable speed drives (VSD)

#### General Requirements

- a) Maximum and minimum speed limit independently adjustable from 0% to 120% of rated motor speed.
- b) Acceleration and deceleration times independently adjustable by way of variable ramp rates and times.
- c) Critical speed skipping at three adjustable frequencies.
- d) VSDs shall have the following features:
  - Drive run/stop input
  - Drive Latch start
  - Drive Stop reset
  - Drive running output
  - Drive fault output
  - Manual speed control via electronic faceplate.
  - Remote speed control (4-20ma).
  - Current signal output (4-20ma)
  - Speed (frequency) signal output (4-20ma)
  - Full load efficiency greater than 96%
  - Average supply power factor of 0.96cos $\phi$  over full operating range
- e) VSD's shall be provided with a keyboard and display unit for VSD configuration, manual control and indication. The keyboard and display unit shall allow use without the need to open the VSD cabinet door(s). Manual control and indication shall include manual start/stop control, drive status, indication and alarms and fault interrogation.
- f) VSDs shall be equipped with a Modbus RTU (via RS485) or Modbus TCP interface.
- g) Modbus RTU/Modbus TCP communications features
- h) Provision for CAT3 safe torque off shall be included as standard.

#### Power Rating

- a) The VSD's continuous current rating shall exceed the motor name plate current rating by a minimum of 10%. The VSD's overload current rating shall exceed the motor's name plate current rating by a minimum of 20% for a period of 60 seconds every 10 minutes.
- b) VSDs shall provide a minimum of 150% of full load torque at start-up. The VSDs shall provide an automatic voltage boost by measurement of motor current to prevent stalling of the motor at start-up or during any portion of the run-up. Any de-rating of the drive due to temperature or alterations to switching frequency shall not detract from the power requirements.
- c) The power supply will be derived from a fused isolator or circuit breaker within the supply switchboard.

#### EMC/RFI

- a) The VSDs shall comply fully with the requirements of the Radio Communications Interference Notice 1993, including amendments 1 - 4. Any filters or other means necessary to achieve compliance shall be included.

- b) The VSD shall include integrated radio frequency suppression according to the requirements of AS/NZS CISPR 11:2002 or equivalent.

### **Cabling**

- a) The cable shall minimise capacitance of the power conductors and have electrically balanced construction including split earths and a copper screen.
- b) The supplier shall declare the required cable types, sizes and formats necessary to comply with the requirements for current carrying capacity, system earthing, installation conditions, maximum lengths, EDM mitigation and other functional requirements set out by the design specification.

### **Harmonic Mitigation**

- a) The VSD supplier shall be required to take full consideration of the potentially detrimental effect of VSD generated harmonics on the power supply system and other connected loads. Any proposed additional equipment shall be supplied with the calculated reduction in harmonic levels.
- b) The harmonic voltage limitation shall be as defined in AS/NZS 61000 and NZECP36 at the Point of Common Coupling (PCC) for the power supply parameters given.
- c) Consideration shall be taken of the power supply impedances, existing harmonic levels and other loads connected to the power system. Identify all measures necessary to ensure maximum acceptable values of harmonic voltage and current distortion are not exceeded and will not result in any detrimental effects on other equipment connected to the same power system.

### **Protection**

- a) The VSDs shall have built-in motor thermal protection by electronic current sensing.
- b) The VSDs shall be capable of withstanding a short circuit between phases and to ground at the output terminals without damage.
- c) Under heavy loads the VSDs protection shall trip as appropriate to prevent damage to itself or the motor.
- d) In the event of a supply interruption or excessive voltage drop at the input to the VSD, the control circuit shall shut down the drive system in an orderly manner without damage or operation of fuses or circuit breakers. Immediate restart shall be possible after resetting any alarms. For voltage interruptions with duration of less than 50 ms the VSD shall be able to ride through the voltage dip and continue to function normally when the voltage returns to acceptable limits.
- e) The VSDs shall incorporate a log of the causes of the last 10 trips.
- f) An option shall be provided to allow the VSD to automatically restart without damage or tripping when connected to a spinning motor after a brief interruption to the supply voltage.

### **Enclosure**

- a) The enclosure shall be to the Vendor's standard, with IP ratings and mountings as specified. The enclosure shall be rated for a minimum of IP54.
- b) Access for operation and maintenance shall be the front only.
- c) The VSDs shall operate within the manufacturer's guaranteed performance and reliability figures at any ambient temperature between 0°C and 40°C. Where necessary, the manufacturer shall provide additional forced cooling to maintain temperatures at the VSD within acceptable operational limits for the above ambient temperature range. Where forced cooling is required within the enclosure, an alarm facility for fan failure shall be provided. Calculations or Type Test Results shall be provided to verify the adequacy of the ventilation fans for maintaining the temperature within the acceptable limits, taking into consideration any filters, where provided.
- d) VSDs shall have special protection in the form of a conformal coating for components to protect against damage from H<sub>2</sub>S rich atmosphere, where applicable.

- e) The doors shall have concealed hinges and 135° full swing around a vertical axis. Doors shall be effectively earthed by flexible copper braids. The doors shall have a resilient, full perimeter neoprene gasket.
- f) Welds shall be full fillet of neat appearance with all scale and weld spatter removed. Visible welds shall be ground and treated so that they conform in appearance and finish to the component material used. Welding shall be performed to minimise internal stress and to prevent distortion.
- g) Where appropriate and depending on the size, make and model of the VSD Unit, the following shall apply:
  - i. A gland plate shall be provided for cable entry. The gland plate shall be removable and of the following material:
    - For multicore cables - PVC with internal galvanised cable/screen support clamps aluminium 3 to 5 mm thick
    - For single core cables – aluminium 5 mm thick
    - The conductors and cable cores shall be identified by appropriate coloured sleeves.
  - ii. An earth bar shall be provided within the enclosure. All non-current carrying metal parts shall be earthed by connecting to this bar.
- h) Floor standing VSDs shall be mounted on a steel plinth.

**Motors**

- a) Where PWM VVVF VSDs are offered, the supplier shall provide a guarantee against damage to the motor bearings caused by Electro Discharge Machining (EDM) and other related phenomenon. The measures to be taken shall be fully described in the tender submission.
- b) The motor insulation shall not be stressed by high switching speeds or the voltage reflection effect. The Tenderer shall provide details of any motor cable length, type or configuration restrictions and optional details for output reactors/cable terminators in case it is necessary to exceed the critical cable length.
- c) The VSDs will be used with standard (not inverter) duty motors. Harmonics produced by the VSD shall not require any de-rating of the motor due to any additional heating caused by harmonic currents. dv/dt filters shall be provided for uses where the insulation integrity of the motor is old or unknown.

**Parameter Set**

- A full parameter sheet shall be supplied for each installed VSD.

*13.13.12.1 Procurement schedule*

Minimum standard required	Design specific requirements	Supplier submission
Application use description		
Critical speed skipping frequencies		
Communication options for control and diagnostics		
E-stop provisions		
Drive de-rating		

Minimum standard required	Design specific requirements	Supplier submission
Cable requirements		
Harmonic mitigation measures		
Enclosure IP rating (min. IP54)		
Enclosure mounting requirements		
Special environmental protection requirements		
VSD cooling requirements		

**Standardised products**

Product model/name	Image	Manufacturer/supplier	Specific limitation
Schneider ATV series		Schneider Electric	
Powerflex 750 series		NHP Electrical Products (NZ) Ltd.	
ABB ACS and AQC series		ABB	
Power Electronics SD750		Power Electronics	

Xylem Hydrovar		Xylem	Only for local network water booster pump stations
Aqua Drive		Danfoss	By design and specific to sites (e.g. Mangere WWTP)

### 13.13.13 Air circuit breakers (ACB)

#### **General Requirements**

LV Air Circuit Breakers (ACB) shall be of the draw-out type, with matching current transformers and solid-state protection unit. The solid-state protection unit shall have over current short circuit and earth fault characteristics adjustable on time and current basis. The circuit breaker shall have the following accessories:

- Motor operated, spring charged operating mechanism (close-open-close cycle before recharge)
- Handle for hand charging the spring
- Close - open push button
- Spring "charged" - "discharged" mechanical indicators
- Key locks for "connected", "disconnected" and "test" position
- Door interlock
- Functional position indicator: "connected", "disconnected" and "test" position
- Breaker "on" and "off" indication
- Padlocking facilities in "disconnected" or "test" position
- Fault trip indicator/breaker reset push button
- Operation counter
- Under voltage release / Shunt trip / Closing coil
- 2NO + 2NC auxiliary contacts
- Safety shutters on busbar and cable side with pad locking facility.
- On and off push buttons
- Separate earth fault relay with a current transformer mounted on the neutral

The short circuit breaking capacity of the circuit breaker shall be equal to or more than the busbar fault level.

Current transformers shall comply with applicable standards and shall be supplied to suit the protection and metering being provided. Unless otherwise shown the metering current transformers shall be of accuracy class 1 and 7.5 VA burden. All C.T.'s shall have the same secondary current rating of 1 Amp.

**Standardised products**

Product model/name	Manufacturer/supplier	Specific limitation
<b>Circuit Breakers - ACB</b>		
Schneider	Schneider Electric	
NHP Terasaki AR series	NHP Electrical Products (NZ) Ltd.	
ABB	ABB	

## 13.14 Acoustic louvers

**General requirements**

- a) Units shall have neatly mitred, tightly butted corners, and shall be free of rattles.
- b) The louver shall be constructed from powder coated aluminium.
- c) Sound absorbent splitters shall have acoustic infill of mineral Rockwool, Fibreglass or other approved acoustic material. The infill shall be to ISO 9705:1993 or ISO 5660, group number 1, 2 or 3.
- d) The acoustic infill shall be faced to prevent fibre carry over and covered by perforated galvanised sheet steel.
- e) Louvers shall be supplied complete with vermin/bird mesh.
- f) Louvers subject to internal moisture ingress or moisture in the air stream shall have Melanex or equivalent moisture resistant internal lining.
- g) The louvers shall have a powder coated finish of a colour to be specified by the Engineer.
- h) To enhance corrosion resistance of louvers, each component shall be powder coated on both sides before assembly.
- i) All visible surfaces of the assembled louver shall again be powder coated on completion to cover fixings etc.
- j) Provide powder coated flashings, channels, flanges and pre painted rivets that are required to complete the installation.

**Accepted products**

Product model/name	Manufacturer/supplier	Specific limitation
AL-300W, AL-450W, AL-600W	Ventüer Limited	By design

## 13.15 Handrails, balustrades and access structures

**General requirements**

- a) The design shall comply with the NZ Building Code, or an alternative solution accepted by the NZ Building Code such as AS 1657.

- b) All structural design shall be to AS/NZS 1170
- c) All designs shall be supported with a Producer Statement (PS1) to confirm compliance with the applicable standards.
- d) Material selection shall be appropriate for the surrounding environment.
- e) Where handrails are installed, it shall be continuous along the length of installation, with no spaces or gaps
- f) Entry to caged ladders shall provide adequate overhead clearance to allow for safe entry.
- g) All sharp edges across fixtures shall be smoothed to prevent injury.
- h) All points of access shall have the necessary controls in place to prevent unauthorized entry. Examples may include raised support brackets and lockable ladder security.
- i) All padlock fittings shall be heavy duty and weatherproof.

Listing No.	Product model/name	Manufacturer/supplier	Application	Limitation
1	Moddex modular handrails and balustrades	Moddex	Water and Wastewater	By design
2	Modular handrails and balustrades	Monkeytoe	Water and Wastewater	By design

## 13.16 Products for the protection and repair of concrete structures

### General requirements

- a) The products must comply with BS EN 1504 and be used in accordance with the manufacturer's specifications.
- b) All products must be accompanied by quality assurance certifications, including:
  - ISO 45001
  - ISO 9001
  - ISO 14001

Listing No.	Product model/name	Manufacturer/supplier	Application	Limitation	Conformity / Quality Control
1	MasterEmaco S 5400 (EMACO Nanocrete R4)	BASF	Wastewater	Repair of concrete lining in pipe.	
2	SewperCoat 2000 HS	Kerneos	Wastewater	Calcium aluminate cement (concrete corrosion resistant) mortar repair. Dry spray application grade	
3	Renderoc CaC	Fosroc	Wastewater	Calcium aluminate cement (concrete corrosion resistant)	(Same as SewperCoat 2000 HS)

				mortar repair. Dry spray application grade	
4	SewperCoat PG	Kerneos	Wastewater	Wet spray, low pressure application	Requires approval on case-by-case basis by Watercare
5	Monotop 352N	Sika	Wastewater - manhole benching repair	Small repair areas to correct minor defects. Minimum and maximum thickness as per the product specification	
6	EMACO Nanocrete R2	BASF	Wastewater - manhole benching repair	Small repair areas to correct minor defects. Minimum and maximum thickness as per the product specification	
7	Xypex Admix C-1000NF	Demden	Water & Wastewater waterproofing	Fit for purpose and by specific design	
8	Xypex Biosan 500	Demden	Wastewater corrosion protection	Fit for purpose and by specific design	
9	Purtop 1000	Mapei	Waterproofing membranes	Can be used in contact with potable water	
10	Mapeiflex PU35 CR	Mapei	Sealing expansion and contraction joints	Can be used in contact with potable water	
11	Planitop Sewament XWW4	Mapei	Restoration of damaged concrete in sewage tanks and drains	Not to be used for potable water systems	
12	Sikadur Combiflex SG, Sikadur 31 CF Normal, Sikaflex – 11 FC, Sikaflex PRO-3 Purform	Sika	Protection and repair of concrete works	Can be used in contact with potable water systems	
13	Adesilex PG1	Mapei	Structural repair, bonding and reinforcement of concrete elements	Not to be used for potable water systems	

14	Mapelastic Smart	Mapei	Waterproofing	Can be used in contact with potable water	
15	Planitop Smooth and Repair R4 Zero	Mapei	Concrete repair	Can be used in contact with potable water	
16	Sikagard- 7000 CR	Sika	Protect concrete infrastructures in harsh conditions	Not to be used for potable water systems	
17	Xypex Concentrate	Demden	waterproofing fine cracks		
18	Xypex PnP	Demden	Reinstate concrete for waterproofing purposes.		
19	Xypex Megamix I	Demden	Repair & relining of water structures		
20	Xypex Megamix II	Demden	Repairs and relining of water and wastewater structures		
21	Xypex Megamix II with Biosan	Demden	Repair & relining of wastewater structures subjected to MIC/Biogenic attack in sewage environment	Not to be used for potable water systems	

## 14 Miscellaneous accepted products



Listing No.	Product model/name	Manufacturer/ supplier	Application	Limitation	Conformity / Quality Control
<b>Hydrant parts</b>					
1	Hydrant Tee		Water networks	Z-ring type	AS/NZS 2280 Ductile Iron Pressure Pipes and Fittings
2	Hydrant marker	Road Mark Systems			Thermoplastic triangle
3	Polyurethane Hydrant Washers	N & P Industries - James Walker	Water networks		
<b>General pipe and fittings</b>					
4	Aqualiner / Micro liner	Aquatech	Wastewater internal pipe repair	Small pipe size. Large pipe requires design input from supplier	
5	Pipe fittings: Copper Alloy Brass	Spartan Engineering; Mason Engineers Ltd	Water networks	50mm and below	DZR, PN16
6	Post formed uPVC pipe bend	Solo plastics	Water networks		
7	EBCO 2, 4, 6 port manifold	Ebco/WSP	Multiple-meter connections	6-port, to be installed with 2" supply at port entry necked-down. Length of supply must be checked for adequate flow	BS EN 1982
8	2,3,4-way stainless manifold	Impact eng./Promains	Multiple-meter connections		
<b>Valve repairs</b>					
9	<b>Valve Packing:</b> "Superlon" 1724 PTFE	Stevenson Chesterton Packing Division	Water networks	Valves up to 250mm	
	"Sepco" ML2254 Teflon	N & P Industries			
	Valve Cones on 100 mm and 150 mm valves	N & P Industries - James Walker			
10	Valve Rubber Stem Cone	N & P Industries - James Walker	Water networks		

Listing No.	Product model/name	Manufacturer/supplier	Application	Limitation	Conformity / Quality Control
11	Valve - non-return	WaStop	Wastewater networks	Stainless Steel version. low pressure flood and odour protection only	SS 316 grade
<b>Tracer wire and buried service identification tape</b>					
12	Trace-Safe RT1802W	Neptco	Water and Wastewater	Use with proprietary connectors and tracing point	
13	Copperhead SoloShot	Copperhead industries / Cory's Electrical	Water and Wastewater	Use with proprietary connectors and tracing point	
14	Copperhead HighStrength	Copperhead industries / Cory's Electrical	Water and Wastewater	Use with proprietary connectors and tracing point	
15	ELV cable 4 core, 4mm copper, PE sleeved		Water and Wastewater		
16	Warning strip tape		Water and Wastewater	Minimum 100mm wide	Colour to AS/NZS 2648 Manufacture and testing to AS/NZS 4275
<b>Process equipment</b>					
17	Mixtec dynamic mixers	Western engineering	Process mixing	Specific design	Individual components
18	Mixtec static mixers	Western engineering	Process mixing	Specific design	Individual components
19	Statiflow mixers	Plastic Systems Asmuss	Process mixing	Specific design	Individual components
<b>Other</b>					
20	HiBuild 1000 Acrylic Paint	Paint Plus	Water and Wastewater	Colour codes: White, blue, black and road marking yellow to mark valves service connections, ducts and fire hydrants respectively. Not to be used for corrosion protection	
21	Strainers – manufactured basket type		Water	Strainers must be a basket type manufactured from approved pipe material and flanges with a stainless-steel removable mesh. Mesh size must be determined with consultation of material supplier of downstream equipment	Applicable pipe material section of this standard

Listing No.	Product model/name	Manufacturer/supplier	Application	Limitation	Conformity / Quality Control
				to be protected. Where specified, these shall be endorsed for use in fire supply lines.	
22	Strainers – y or inline strainer		Water	Fit for purpose	<p>All components in contact with water shall comply with AS/NZS 4020</p> <p>Brass fittings shall be dezincification resistant (DR/DZR)</p> <p>DI fittings shall comply with section 13.1.11</p> <p>Flanges shall comply with section 13.4</p>
23	Diaphragm isolation valve (DVC25020MT)	Acuflo	Water	Used with inline water meters	<p>All components in contact with water shall comply with AS/NZS 4020</p>

## 15 Standard product solutions

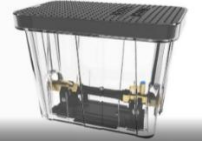
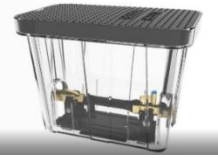
### 15.1 Domestic meter solutions

Product code	Product description	Image	Data download/additional info	Supplier
SCMB-1BSPDCV20	<p>Meter box assembly for threaded connection 20mm includes:</p> <p>Box and base</p> <p>Isolation valve</p> <p>Removable spacer</p> <p>Dual check valve</p>		N/A	<p>Promains</p> <p>Hygrade/Hynds</p> <p>Humes</p> <p>WSP</p>
SCMB-1PEDCV20	<p>Meter box assembly for PE compression fit, 20mm includes:</p> <p>Box and base</p> <p>Isolation valve</p> <p>Removable spacer</p> <p>Dual check valve</p>		N/A	<p>Promains</p> <p>Hygrade/Hynds</p> <p>Humes</p> <p>WSP</p>
DN20 KIT	<p>Domestic meter maintenance kit, 20mm includes isolation valve and dual check valve</p>		N/A	<p>Promains</p> <p>Hygrade/Hynds</p> <p>Humes</p> <p>WSP</p>
<p>ZC7094DCV (PE compression)</p> <p>ZC707925/ZC7094 (PE Repair kit)</p> <p>ZC9746DCV (BSP)</p> <p>ZC9746/ZL6850DCV (BSP Repair kit)</p>	<p>Ball valve with integrated dual check valve</p>		N/A	<p>Promains</p> <p>Hygrade/Hynds</p> <p>Humes</p> <p>WSP</p>

ZL6850DCV	20mm Dual check valve-60mm long			Promains Hygrade/Hynds Humes WSP
ZC6850D	20mm meter tail-50mm long			Promains Hygrade/Hynds Humes WSP
ZL6850DCV/ZC6850D	20mm dual check valve/meter tail kit			Promains Hygrade/Hynds Humes WSP